

MCWP 3-15.3 (formerly FMFM 1-3B)

Sniping



U.S. Marine Corps

PCN 143 000118 00

MCCDC (C 42)
27 May 2004

E R R A T U M

to

MCWP 3-15.3

SNIPING

1. Change the publication short title to read "MCWP 3-15.3" (vice FMFM 1-3B). Change PCN to 143 000118 00.

PCN 143 000118 80

DEPARTMENT OF THE NAVY
HEADQUARTERS UNITED STATES MARINE CORPS
WASHINGTON, D.C. 20380

28 January 1981

FOREWORD

1. PURPOSE

FMFM 1-3B, *Sniping*, sets forth the techniques and procedures for selecting, training, and employing scout-snipers within the Fleet Marine Forces.

2. SCOPE

FMFM 1-3B complements, and is designed to be utilized with, FMFM 1-3, *Basic Rifle Marksmanship*, and FMFM 1-3A, *Field Firing Techniques*. This manual addresses the scout-sniper's selection, training, and equipment and its care. It also provides guidance in the proper and effective methods of employment of scout-snipers.

3. SUPERSESSION

FMFM 1-3B, *Sniping*, dated 7 April 1976.

4. CHANGES

Commanding General
Doctrine Division (C 42)
Marine Corps Combat Development Command
2042 Broadway Street Suite 210
Quantico, VA 22134-5021

5. CERTIFICATION

Reviewed and approved this date.

BY DIRECTION OF THE COMMANDANT OF THE MARINE CORPS



RICHARD E. CAREY
Lieutenant General, U.S. Marine Corps
Commanding General
Marine Corps Development and Education Command
Quantico, Virginia

DISTRIBUTION: TAE

Reviewed and approved for
reprinting by CMC (Code PP)
on 17 JAN 1984.

User Suggestion Form

From:

To: Commanding General, Doctrine Division (C 42), Marine Corps Combat Development Command, 2042 Broadway Street Suite 210, Quantico, Virginia 22134-5021

Subj: RECOMMENDATIONS CONCERNING FMFM 1-3B, *SNIPING*

1. In accordance with the foreword to FMFM 1-3B, which invites individuals to submit suggestions concerning this FMFM directly to the above addressee, the following unclassified recommendation is forwarded:

Page	Article/Paragraph No.	Line No.	Figure/Table No.
------	-----------------------	----------	------------------

Nature of Change: Add
 Delete
 Change
 Correct

2. Proposed new verbatim text: (Verbatim, double-spaced; continue on additional pages as necessary.)

3. Justification/source: (Need not be double-spaced.)

Note: Only one recommendation per page.

(reverse blank)

RECORD OF CHANGES

CHANGE No.	DATE OF CHANGE	DATE OF ENTRY	ORGANIZATION	SIGNATURE

SNIPING

TABLE OF CONTENTS

SECTION 1		THE SCOUT-SNIPER	
Paragraph			Page
101	Definition		1-1
102	Dual Mission		1-1
103	Operational Concept		1-2
104	Sniper Team		1-2
105	Organization		1-4
106	Duties		1-5
107	Selection of Personnel		1-6
SECTION 2		SNIPER EQUIPMENT	
201	Rifle, M40A1		2-1
202	Telescopic Sight		2-2
203	Ammunition		2-9
204	Observation Aids		2-10
205	Starlight Scope		2-15
206	Care and Cleaning of Rifle and Equipment		2-22
SECTION 3		MARKSMANSHIP TRAINING	
301	Purpose		3-1
302	Fundamentals		3-1
303	Progressive Training		3-1
304	Sighting and Aiming		3-2
305	Trigger Control		3-5
306	Shooting Positions		3-6
307	Quick Kill Method		3-12
308	Observer, Shooter Positioning		3-13
309	Zeroing		3-14
310	Effects of Weather		3-17
311	Holds and Leads		3-20
SECTION 4		FIELD SKILLS	
401	Target Detection and Selection		4-1
402	Range Estimation		4-5

403	Camouflage	4-9
404	Individual Movement	4-16
405	Occupation and Selection of Positions	4-28
SECTION 5	SNIPER SKILLS	
501	Range Card, Log Book, Field Sketching	5-1
502	Collection and Reporting of Information	5-12
SECTION 6	SNIPER TACTICAL EMPLOYMENT	
601	General	6-1
602	Offensive Combat	6-5
603	Defensive Employment	6-16
SECTION 7	PLANNING AND PREPARATION OF A SNIPER MISSION	
701	Introduction	7-1
702	Sniper Employment Officer	7-1
703	Patrol Steps	7-6
704	Warning Order	7-11
705	Patrol Order	7-12
706	Arm-and-Hand Signals	7-13
707	Basic Fire Support Planning and Control	7-13
708	Zone Briefs	7-18
APPENDIXES		
A	Range Estimation Tables	A-1
B	Basic Sniper Training Syllabus	B-1
C	Marksmanship Exercises	C-1
D	Sniper Training Exercises	D-1
E	Windage Conversion Table	E-1
F	Building Terrain Models	F-1
G	List of References	G-1
INDEX		



SECTION 1

THE SCOUT-SNIPER

The Marine Corps sniper is a Marine who has been carefully screened, selected, and has undergone comprehensive training in advanced infantry and marksmanship techniques. The sniper's training, combined with the inherent accuracy of his rifle, firmly establishes him as a valuable addition to the supporting arms available to the infantry commander.

101. DEFINITION

The scout-sniper is a Marine highly skilled in fieldcraft and marksmanship who delivers long range, precision fire at selected targets from concealed positions.

102. DUAL MISSION

The primary mission of a sniper in combat is to support combat operations by delivering precision fire on selected targets from concealed positions. The sniper also has a secondary mission of gathering information for intelligence purposes.

Selected Targets. Those targets that will have a definite influence on the outcome of the battle and the enemy's ability to wage battle, such targets as:

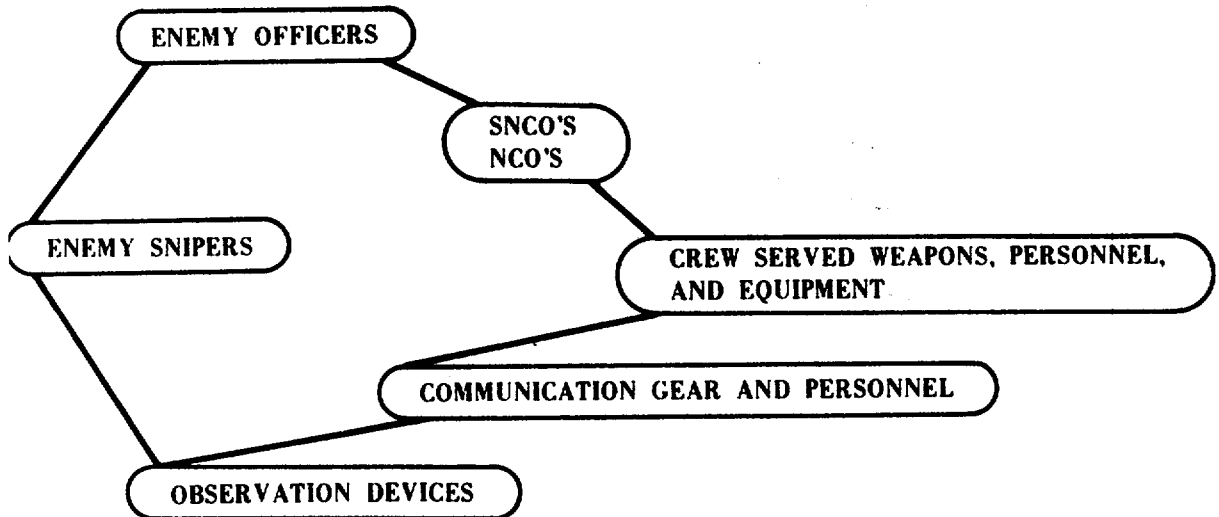

103. OPERATIONAL CONCEPT

A *two-man team* is the basic operational organization for the employment of snipers. *Both* team members are trained scout-snipers with the additional MOS of 8541.

104. SNIPER TEAM

Each sniper team consists of a team leader and a scout-sniper. Both are trained 8541's. Each team is equipped with:

- M40A1 sniper rifle with a UNERTL 10X telescope
- Standard M16 service rifle
- M49 20X spotting scope
- Wide-angle binoculars with mil scale
- .45 caliber service pistols
- Starlight scope if necessary
- Radio

Either member of the team can fill the function of the sniper (with the M40A1 sniper rifle); the other member is armed with the standard service rifle and fills the function of the observer.

Besides actual sniper skills, the sniper team is additionally trained in:

SUPPORTING ARMS FIRES PLANNING AND CONTROL

INFANTRY TACTICS

**MAP AND AERIAL PHOTO READING/
LAND NAVIGATION**

**INFORMATION GATHERING
AND REPORTING**

COMMUNICATIONS/ZONE BRIEFS

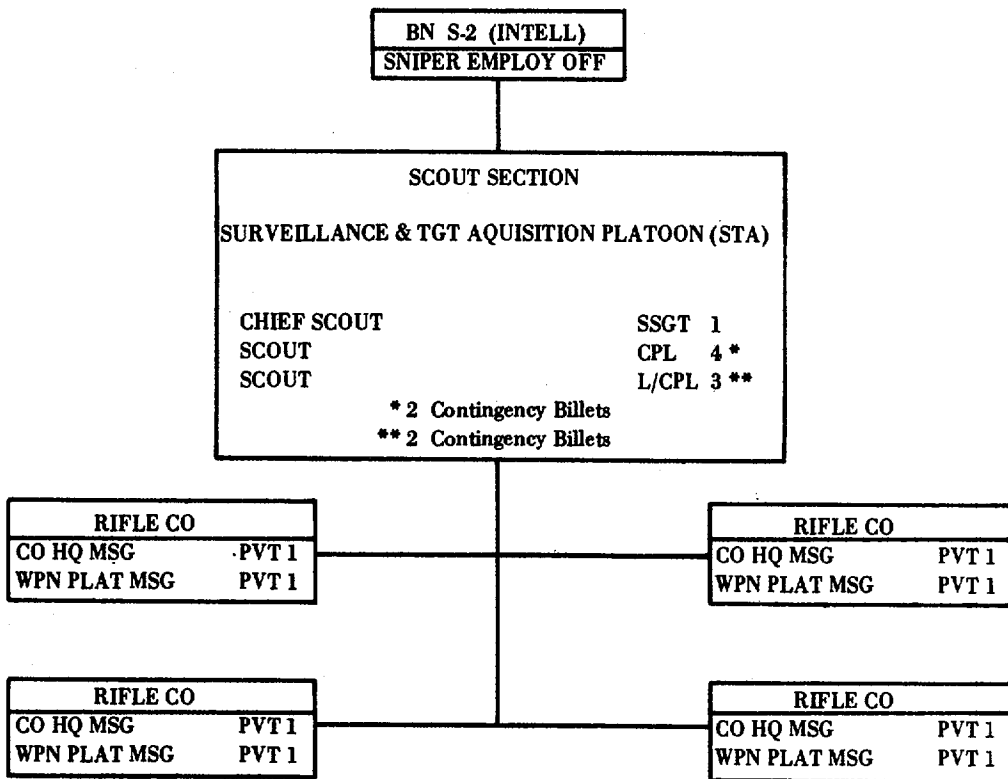

Figure 1-1. Sniper Team Leader Calling in Support.

105. ORGANIZATION

Sniper teams are currently maintained on an additional/collateral duty basis within the infantry battalions. There is a *contingency plan* for sniper billets at the regimental level as well.

H&S CO. INFANTRY BATTALION T/O 1037M *
SCOUT SNIPER ORGANIZATION



* AS OF CMC MSG 301417Z MAR 77
(No change to date to reflect new battalion organization.)

Figure 1-2. Scout Sniper Organization.

**SNIPER ORGANIZATION
CONTINGENCY MANNING**

**HQ CO. INFANTRY REGIMENT T/O 1096M *
SCOUT SNIPER PLATOON**

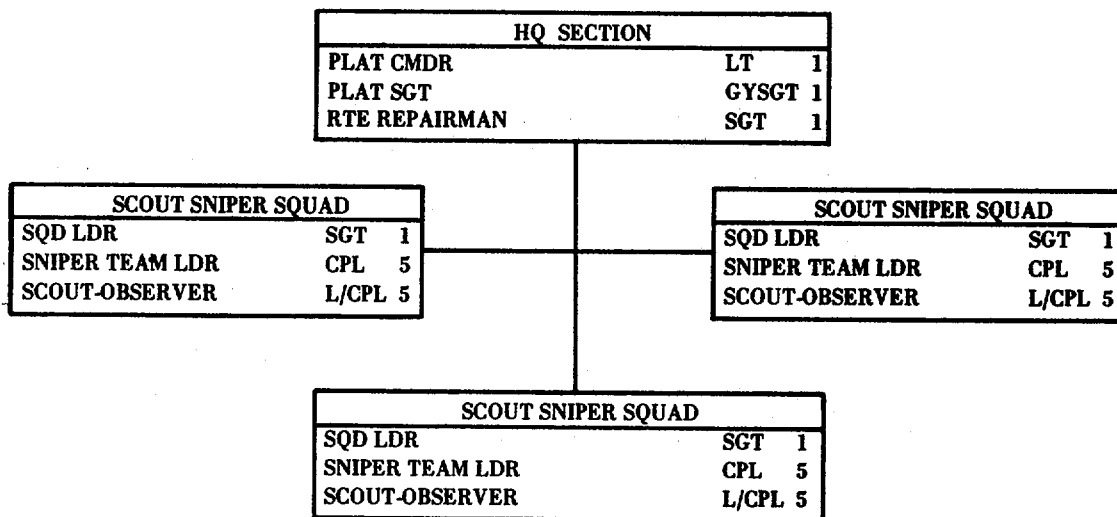

* CONTINGENCY MANNING

Figure 1-3. Scout Sniper Platoon.

106. DUTIES

The *sniper employment officer* is directly responsible to the battalion commander for the operational efficiency of his designated sniper teams. He advises the battalion and company commanders on the correct employment of their sniper teams. He ensures that proper maintenance and security is provided for sniper weapons and equipment.

SNIPER RIFLE SYSTEMS ARE TO BE USED BY SNIPERS FOR SNIPING AND SNIPER PROFICIENCY TRAINING ONLY. UNTRAINED PERSONNEL SHOULD NOT HANDLE OR MANIPULATE THE RIFLE OR THE TELESCOPE.

The *sniper team-leader* is responsible for the effective employment of his team and the care of its weapons and equipment. When attached, he assists the commander of the supported unit in the control of the team and makes recommendations relative to proper sniper team employment.



Figure 1-4. Sniper Team Briefing.

107. SELECTION OF PERSONNEL

Candidates for sniper training must be carefully screened. The rigorous training program and the great personal risk in combat require high motivation and the ability to learn a variety of highly technical skills. Potential snipers must have an excellent record and *must be carefully screened* by their unit commanders to determine their potential aptitude as a sniper.



Figure 1-5. Selecting a Sniper.

Battalion and company commanders must ensure that *only the best Marines* are selected for sniper training. Anything less than the best will not be able to meet the graduation standards of the sniper course and will waste valuable Marine Corps time and money.



No commander likes to send his best people to fill a school quota (especially since he may lose that Marine to battalion when referring to a platoon or company commander). The commander must look at the larger picture of helping his battalion and the Marine Corps by giving them the asset of a valuable, highly trained, supporting arm. The commander's loss is the battalion's and Marine Corps' gain. Select only the best—quota fillers are not acceptable!

REQUIREMENTS FOR POSSIBLE SNIPER CANDIDATES:

PHYSICAL CONDITION

- FIRST CLASS PFT SCORES
- STAMINA
- ATHLETE/COORDINATION

GLASSES

- LIABILITY UNLESS HIGHLY QUALIFIED

MARKSMANSHIP

- REPEATED ANNUAL REQUAL OF EXPERT

INTELLIGENCE

- MUST BE ABLE TO LEARN, APPLY, AND TEACH A WIDE VARIETY OF TECHNICAL SKILLS
- DECISIVENESS
- KNOWLEDGE OF INFANTRY TACTICS/SKILLS
- COMMON SENSE/INGENUITY

EQUANIMITY

- NO UNCONTROLLED EMOTIONS
- CALM UNDER STRESS

FIELD CRAFT

- AT HOME IN THE FIELD
- BACKGROUND IN THE WOODS
- CONFIDENCE WITH MAP AND COMPASS

LEFT HANDED

- LIABILITY UNLESS HIGHLY QUALIFIED

TOBACCO HABIT

- LIABILITY UNLESS HIGHLY QUALIFIED

MENTAL CAPABILITY

- THINKS FOR HIMSELF
- SELF-CONFIDENCE
- ABILITY TO BE EMPLOYED INDEPENDENTLY
- MATURE

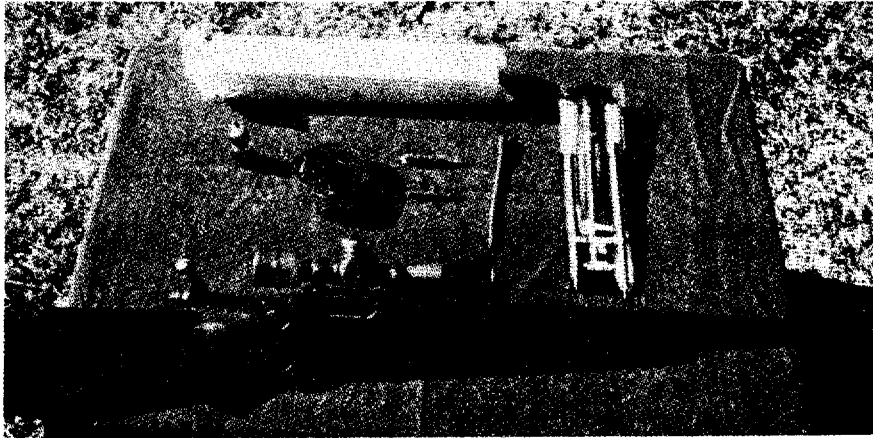

SECTION 2

SNIPER EQUIPMENT

201. RIFLE, M40A1

The sniper rifle used by the Marine Corps is a Marine Corps designed and produced bolt action, 7.62mm rifle with a stainless steel barrel for improved accuracy. It weighs 14 pounds and has a maximum effective range of 1,000 yards. The rifle is fitted with a top-mounted telescope base, to which the sniper scope can be readily attached without special tools. The rifle is furnished with a lightweight fiberglass carrying case with force fitted sponge rubber top and bottom liners.

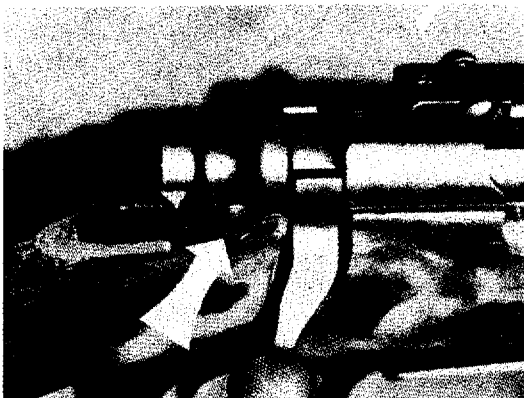

The safety lever is located at the right rear of the receiver, behind the bolt handle. When pulled to the rear, the weapon is on safe.

Figure 2-1. Location of the Safety.

The bolt stop release is located inside the trigger guard just forward of the trigger. When depressed, it allows the bolt to be removed from the rifle.

The floor plate latch is forward of the trigger guard and is opened by pressing the serrated detent on the forward edge of the trigger guard.

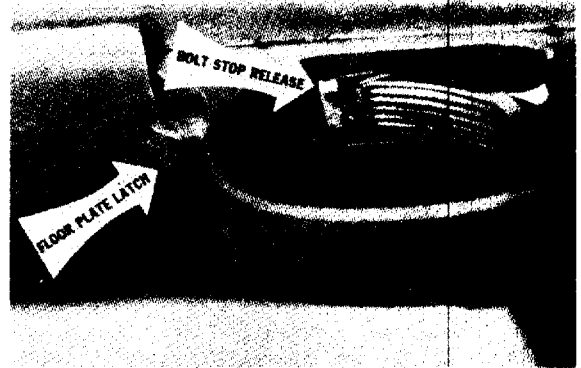

Figure 2-2. Bolt Stop Release and Floor Plate Latch.

**TABULATED DATA
M40A1 RIFLE**

Caliber7.62mm NATO
Length44 inches
Weight14 pounds
Barrel Length24 inches
Lands and Grooves6
Twist, Right Hand1 turn in 12 inches
Trigger Weight.3 to 5 pounds
Torque65 inch/pound
Magazine Capacity5 rounds
Maximum Effective Range . .	.1,000 yards

202. TELESCOPIC SIGHT

A telescopic sight is an instrument which facilitates accurate aiming by use of precision ground lenses and crosshairs in a metal body.

GENERAL

THE OPTICAL SYSTEM

The optical system is composed of a series of glass lenses which transmit and magnify the image of the target to the sniper.

The average unaided eye can distinguish 1-inch detail at 100 yards. Magnification, combined with good optics design, permits resolution of this 1-inch divided by the magnification. Thus, 1/10-inch detail can be seen at 100 yards with a 10X scope.

**MAGNIFICATION
(Resolving Power)**

Lens surfaces are coated with a high efficiency, low reflection (HELRL) film. This coating increases the light gathering capability to approximately 91 percent of the available light. With uncoated lenses, 45 percent of the available light is lost in the scope.

**LENS
COATING**

Field of view is the diameter of the picture seen through a scope, and it is usually expressed in "feet at hundreds of yards."

FIELD OF VIEW

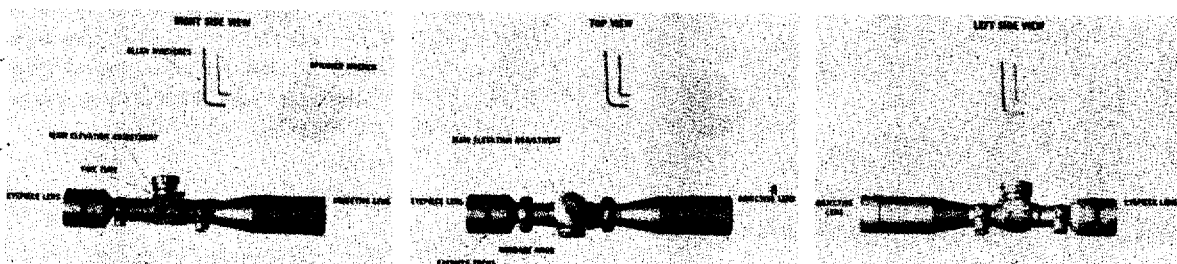

Figure 2-3. UNERTL Sniper Scope.

**UNERTL
USMC SNIPER SCOPE
TABULATED DATA**

- Weight2 pounds 3 ounces
- Length12½ inches
- Magnification10X
- Eye Relief3 inches (fixed)
- Adjustments:
 - Elevation and Windage ½ minute
 - Main ElevationBallistic comeups M118 Lake City; match ammunition 7.62mm caliber); built-in
 - Fine Tune Elevation+ or -3 minutes to adjust for differences in shooter's zeros, temperatures, ammunition lots, ammunition
 - Windage60 minutes main adjustment; + or -4 minutes with stops on either end to allow shooter to run windage on and off in the dark
 - ReticleMil dot duplex for range estimation and calculating leads on moving targets
 - LensesHELRL coating; scope gathers in over 90 percent of available light
- Steel tube with dull black chrome finish.
- Capability of reading elevation and windage settings from the rear while shooting.
- Scope allows shooter to shoot point of aim/point of impact back to 1,000 yards.
- Capability of adjusting parallax.

ADJUSTMENTS

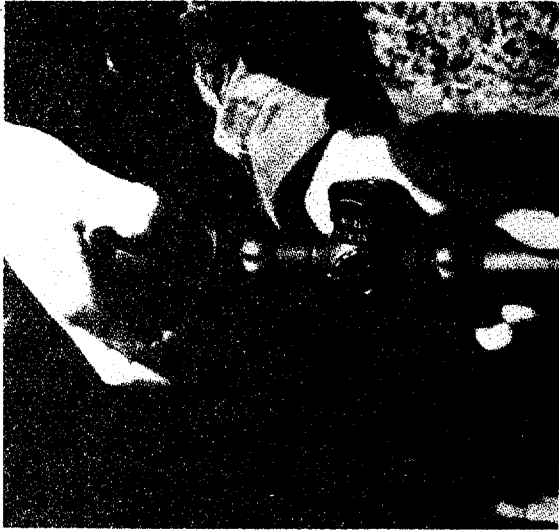
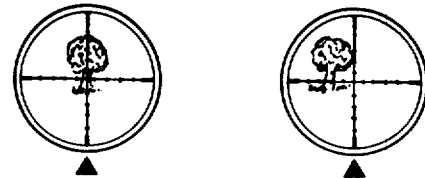

Figure 2-4. Focus Ring Being Rotated.

PARALLAX

Parallax is defined as the apparent movement of an object as seen from two different points not on line with the object. Observe a target at a range of 300 yards. While looking through the scope, move the head vertically and horizontally in small increments. The reticle should not appear to change position on the target. If it does, parallax is present and the objective lens must be focused.



WHEN THE EYE IS CENTERED IN THE SCOPE AND THE CROSSHAIR APPEARS CENTERED ON THE OBJECT THEN YOU MOVE YOUR HEAD SLIGHTLY TO THE LEFT AND THE OBJECT MOVES OFF CENTER OF THE SCOPE PARALLAX IS PRESENT. NO PARALLAX IS PRESENT WHEN THE HEAD CAN BE MOVED SLIGHTLY IN ANY DIRECTION AND THE CROSSHAIR STAYS CENTERED ON THE OBJECT.

FOCUS CHECK

The telescope should be focused to the individual's eye. To check the focus, point the telescope at a distant scene or the sky and drape a white handkerchief over the objective end. Look at a distant scene with unaided eye for several seconds and quickly glance into the eyepiece of the telescope. If properly focused, the reticle should appear instantly, distinct and sharp. If such is not the case, the eyepiece requires focusing.

FOCUS OF THE EYEPIECE

To focus the eyepiece, first unscrew the rear portion of the eyepiece cell several turns. Proper focus can now be set by rotating the knurled focusing ring. Once proper focus has been set, the focusing ring should be locked by screwing in the rear portion of the eyepiece cell until tight.

PARALLAX ADJUSTMENT

To focus the objective lens, first loosen the lock ring at the end of the scope using the proper "spanner" wrench. Loosen this ring only enough to allow the focusing ring adjacent to it to rotate. To focus, rotate the focus ring with one hand, while holding the lock ring with the other to prevent its rotation and to keep it tight against the focus ring. After the focus has been set, tighten the lock ring using the "spanner" wrench while holding the focusing ring with the hand.

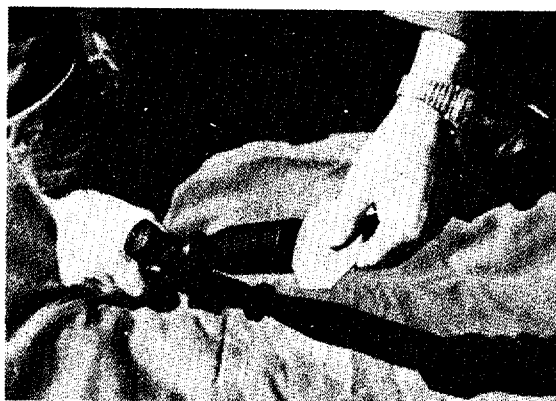

Figure 2-6. Adjusting Parallax With "Spanner."

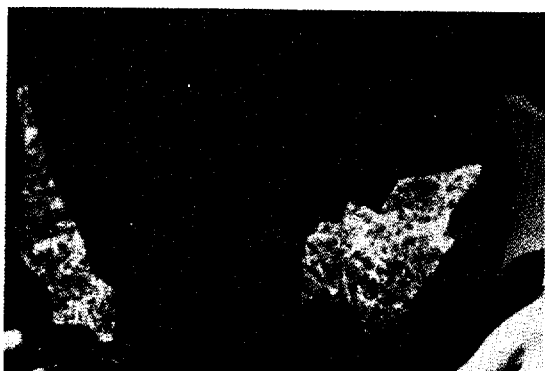

Figure 2-7. Focusing Objective Lens.



Figure 2-8. Final Stage of Focusing Objective Lens.



Figure 2-9. Eye Relief.

EYE RELIEF

When issued, the telescope is set all the way forward in the scope mounting rings. This setting will provide the needed 2- to 3-inch eye relief for almost all shooters. It is possible, however, to move the sight slightly to achieve proper eye relief.

CAUTION: The telescope extends to the rear of the receiver. If proper eye relief is not maintained, recoil may cause the shooter to receive a blow on the forehead.

THE RETICLE

The duplex reticle in the telescope provides the sniper with a range-finding capability. To determine range, the following formula is used:

$$\frac{\text{Height of target (in yards)} \times 1,000}{\text{Height of target (in mils)}} = \text{Range}$$

The dots on the fine crosshairs are 1 mil apart with a total of 5 mils from the center to the thick post in each direction.

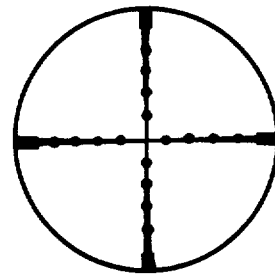

1 mil on the reticle is equal to 1 yard at 1,000 yards

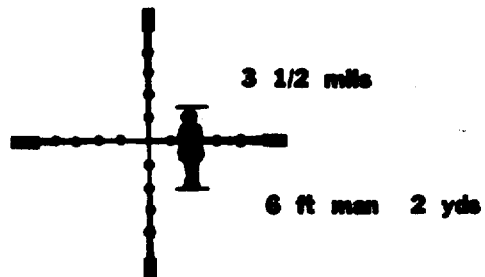

$$\frac{2 \times 1000}{3.5} = 571 \text{ yds}$$

Figure 2-10. Mil Dot Reticle.

ELEVATION AND WINDAGE

Once the scope is zeroed, all the sniper has to do is estimate the range to a target and the windage, and apply those figures to the scope via the main elevation adjustment and the fine tune windage adjustment.

THE SCOPE WILL ALLOW THE SNIPER TO SHOOT POINT OF AIM / POINT OF IMPACT BACK TO 1,000 YARDS.

The main ballistic comeups (for the M118-Lake City Match-7.62mm ammunition) are built into the main elevation adjustment. Once the scope is zeroed, the sniper has simply to dial the desired range on the scope and fire. The main adjustment on the elevation control is marked every 100 yards from 100 to 1,000 yards. For ranges between these figures (example 650 yards), set the dial halfway between 600 and 700 yards. There is also a fine tune elevation control + or -3 minutes to allow for different temperatures, ammunition lots, types of ammunition, and differences in shooters' zeros. The fine tune knob will allow any sniper to shoot point of aim/point of impact back to 1,000 yards.

The windage fine tune knob allows the sniper to apply changes to allow for windage variations of + or -4 minutes.

The scope settings for elevation and windage can be read from the rear while firing, and due to the distinctive clics and built-in stops, on all controls, the sniper can apply his elevation and windage in the dark.

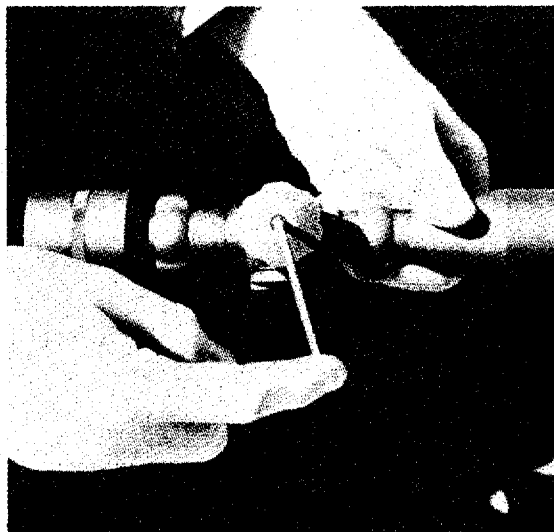

Figure 2-11. Elevation Adjustment Controls.

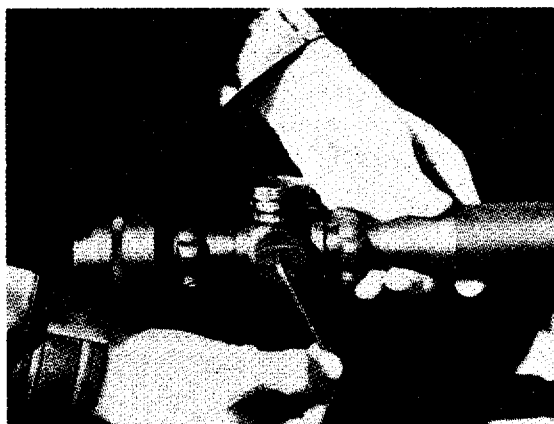

Figure 2-12. Windage Adjustment Controls.

MOUNTING THE TELESCOPE



Figure 2-13. Mounting Scope Sequence (Step 1).

The telescopic sight mount is attached to the rifle by three screws. The forward end of the mount is recessed to accommodate the lug which protrudes from the front mounting ring of the telescope.

The lug and recess are mated with the telescopic sight at a 90-degree angle to the weapon.

The scope is rotated and the eyepiece is brought to the rear until the scope and mount are aligned.

The rear mounting lug is fastened to the mount by means of lock screws on either side of the lug.

These screws also serve as a means for making coarse windage adjustments when zeroing.



Figure 2-14. Mounting Scope Sequence (Step 2).



Figure 2-15. Mounting Scope Sequence (Step 3).

203. AMMUNITION

Match quality ammunition will normally be issued because of its greater accuracy and reduced sensitivity to the wind. However, if match ammunition is not available, or if the situation dictates, a different grade of ammunition may have to be used. In ammunition other than match, accuracy and point of impact may vary noticeably. Among different lots, an especially accurate lot can be identified through use, and it should be used as long as it is available.



Figure 2-16. M118 Match Ammunition.

DATA
MATCH
AMMUNITION

173-Grain Boattail Bullet
 Velocity 2,550 feet per second
 Accuracy Specification3.5 feet mean radius at 600 yards
 Caliber7.62mm M118
 IdentifiersMATCH is stamped on the head, along with the year of production and the initials of the arsenal which produced it (e.g., L.C. identifies Lake City).



Figure 2-17. 7.62mm Ball Ammunition.

DATA
BALL
AMMUNITION

147-Grain Bullet
 Velocity2,750 feet per second
 Caliber7.62mm M80 and M80E1
 IdentifiersThe year of production and the arsenal's initials are stamped on the head.

NOTE: M80E1 is the most accurate of the ball ammunition.
 Because MATCH ammunition is heavier and slower than the other types, it is safe to assume that all other types of ammunition will strike higher on the target.

LAKE CITY M118 MATCH GRADE AMMUNITION WILL BE ISSUED TO THE SNIPER AND SHOULD BE FIRED AT ALL TIMES, WHEN AVAILABLE.

204. OBSERVATION AIDS

The sniper's success in detecting targets, or the signs of enemy presence, is dependent on his powers of observation. To increase his ability to observe well, he is aided by the use of the M49 telescope, binoculars, and the starlight scope. The starlight scope will be discussed in paragraph 205.

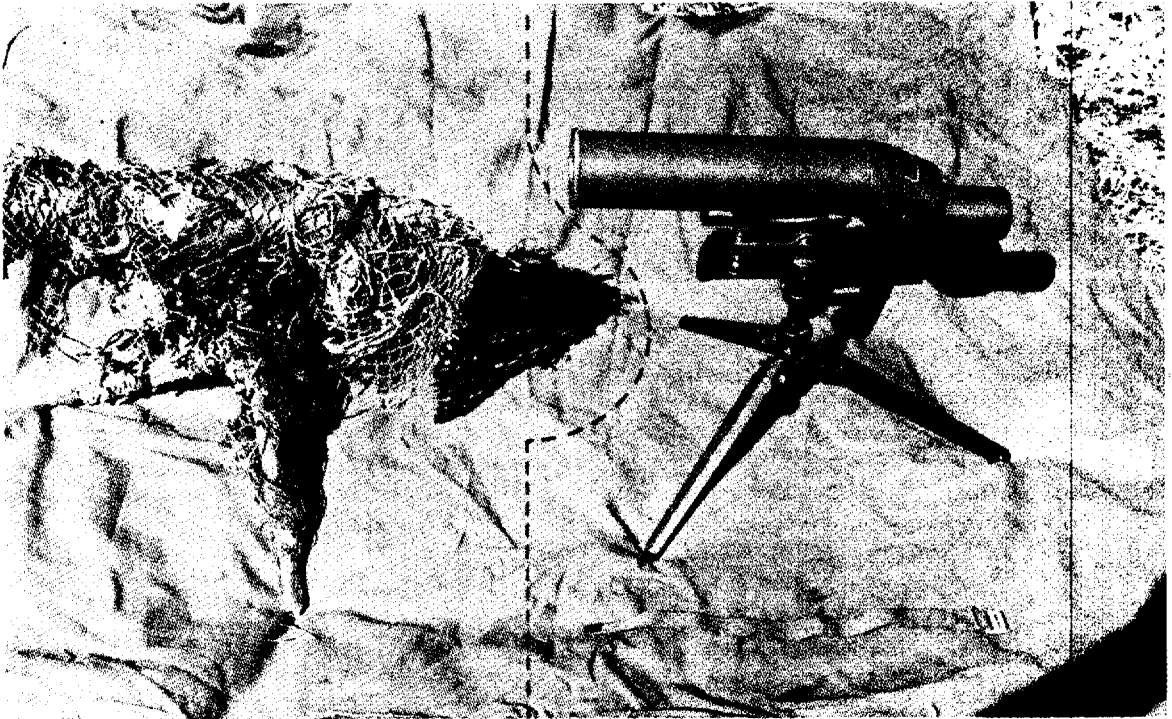

Figure 2-18. M49 Telescope and Tripod (Camouflaged).

Figure 2-19. M49 Telescope and Tripod.

M49 OBSERVATION TELESCOPE

The M49 observation telescope is a prismatic optical instrument of 20-power magnification. The lenses are coated with magnesium fluoride for high light-gathering capability. The scope should be carried by sniper teams when it is justified by their mission. The high magnification of the telescope makes observation and target detection possible when conditions would otherwise prevent it. Camouflaged targets and those in deep shadows can be located, troop movements can be distinguished at great distances, and selected targets can be identified.

OPERATION

FOCUS

The height adjusting collar is to maintain a desired height for the telescope. The collar is held in position by tightening the clamping screw.

The shaft rotation locking thumb screw clamps the tripod shaft at any desired azimuth.

The elevating thumbscrew is used to adjust the cradle of the tripod, to increase or decrease the angle of elevation of the telescope.

The tripod legs can be held in an adjusted position by tightening the screw nut at the upper end of each leg.

SETTING UP THE SCOPE AND TRIPOD

Each sniper team will be equipped with binoculars to aid in observing the enemy and in searching for and selecting targets. The focusing adjustments are on each eyepiece. The left monocular has a mil scale etched into it.

An eyepiece cover cap and objective lens cover are used to protect the optics when the telescope is not in use. Care must be taken to prevent cross-threading of the fine threads.

The eyepiece focusing sleeve is turned clockwise or counterclockwise until the image can be clearly seen by the operator.

M15 TRIPOD

Spread the legs and place the tripod on a level position on the ground so the cradle is level with the target area.

Place the telescope through the strip loop of the tripod and tighten the strap to keep the scope in place and steady.

If the tripod is not carried, an expedient rest should be used for the scope. The scope needs a good steady position if it is to be used properly.

BINOCULARS

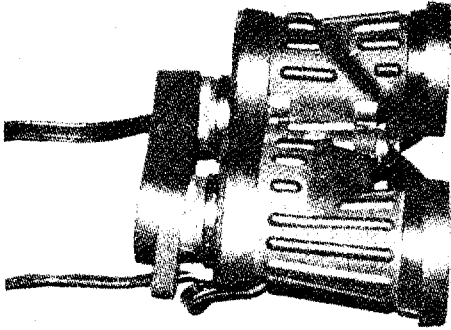

Figure 2-20. "New Issue" Binoculars.



Figure 2-21. Binoculars, Camouflaged.

METHODS OF HOLDING BINOCULARS



Figure 2-22. Method of Holding Binoculars.

Binoculars should be held lightly, resting on and supported by the heels of the hands. The thumbs block out light that would enter between the eye and the eyepiece. The eyepieces are held lightly to the eye to avoid transmitting body movement. Whenever possible, a stationary rest should support the elbows.

An alternate method for holding the binoculars is to move the hands forward, cupping them around the sides of the objective lenses. This keeps light from reflecting off the lenses, which would reveal the sniper's position.



Figure 2-23. Alternate Method for Holding Binoculars.

ADJUSTMENTS

INTERPUPILLARY ADJUSTMENT IS MOVEMENT OF THE MONOCLES TO FIT AN INDIVIDUAL'S EYE

The interpupillary distance is the distance between the eyes. The monoculars are hinged together so that they can be adjusted to meet this distance. The hinge is adjusted until the field of vision ceases to be two overlapping circles and appears as a single, sharply defined circle. The setting of the hinge scale should be recorded for future use.

FOCAL ADJUSTMENT

Each individual and each eye of that individual requires different focus settings. Adjust the focus for each eye in the following manner:

- With both eyes open, look through the glasses at a distant object.
- Place one hand over the objective lens of the right monocular and turn the focusing ring of the left monocular until the object is sharply defined.
- Uncover the right monocular and cover the left one.
- Rotate the focusing ring of the right monocular until the object is sharply defined.
- Uncover the left monocular. The object should then be clear to both eyes.
- Read the diopter scale on each focusing ring and record for future reference.

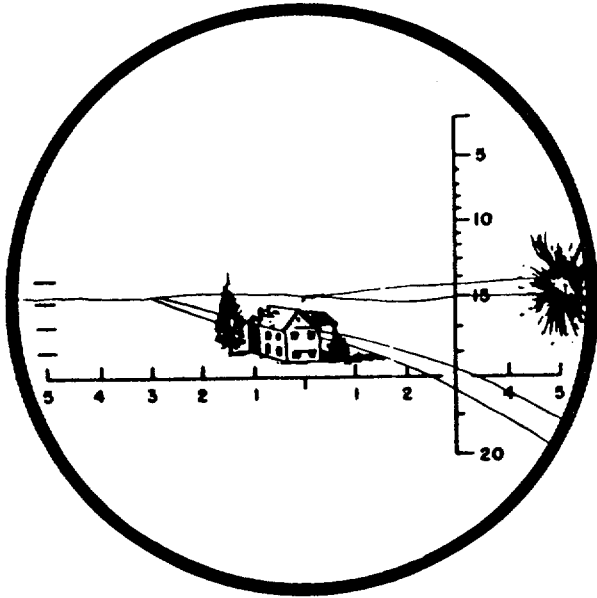

Figure 2-24. Binocular Reticle Pattern.

RETICLE

The mil scale that is etched into the left lens of the binoculars is called the reticle pattern and is used in adjusting artillery fire and determining range to a target. Determining range with the binoculars is done similar to the telescopic sight reticle. The height of the target is measured in mils. This is then divided into the height of the target in yards times 1,000 to give the range to the target in yards. Care should be taken to measure the size of the target to the nearest $\frac{1}{4}$ yard.

In addition to observing and adjusting fire and range estimation, binoculars may be used to:

- Identify troops, equipment, weapons, vehicles, etc.
- Observe enemy movement or positions.
- Locate targets.
- Make visual reconnaissance.
- Study terrain.
- Select routes and positions.
- Improve night vision.
- Improve vision in periods of reduced visibility.

ADDITIONAL USES FOR BINOCULARS

Prolonged use of the binoculars or telescope will cause eye fatigue, reducing the effectiveness of observation. Periods of observation with optical devices should be limited to 30 minutes, followed by a minimum of 15 minutes rest.

EYE FATIGUE

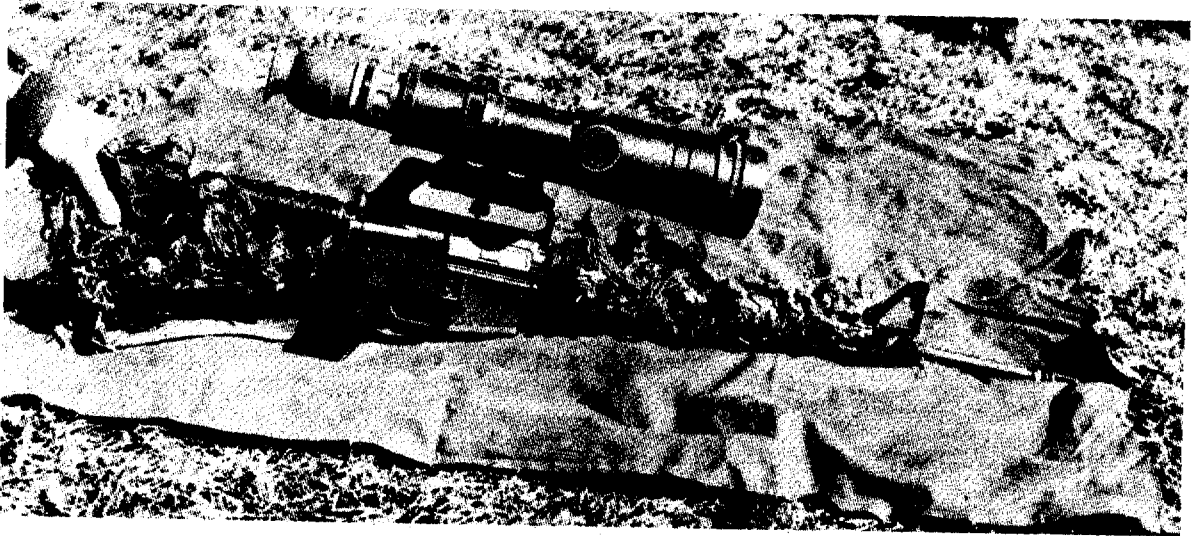

Figure 2-25. Starlight Scope.

205. STARLIGHT SCOPE

The starlight scope is a handheld, battery powered, electro-optical viewing device. The scope uses natural moonlight and/or natural starlight for target illumination. It detects distant and obscure objects at night by amplifying available ambient light to illuminate the objects to such a degree as to make them visible on a screen through the eyepiece. The starlight scope can be used for visual observation or for aimed fire of weapons at night while the user remains free of enemy detection.

The starlight scope is designed for use on the M14 and M16 rifles. Separate weapons adapter brackets are available for mounting the scope to each of these weapons. The starlight is not mounted on the sniper rifle since the effective range of a starlight scope is usually about 300 yards.

APPLICATION

The contents of the mercury battery are highly irritable to the eyes and to oral and nasal tissues; therefore, caution must be exercised when handling the batteries. To prevent explosion, batteries should not be disposed of by burning, but should be buried or dumped into a large body of water.

PRECAUTIONS

Should the image intensifier tube be exposed to intense light, it will automatically cut off to prevent burning out the tube and to protect the eye. However, continuous exposure of an activator tube to intense light should be avoided.

During daylight operations, the lens cap must be positioned over the objective lens. The starlight scope should never be aimed directly at the sun since it will result in a complete failure of the tube.

M14 RIFLE. The weapon adapter bracket is aligned with the groove and screw recess on the left side of the receiver. The bracket is secured to the receiver by tightening the socket head screw with an allen wrench.

M16 RIFLE. The wing nut is unthreaded all the way to the thread stops. The tab is pulled away from the bracket and the mounting ear is pushed under the carrying handle of the rifle. The slotted groove is positioned in the base of the bracket over the top of the receiver group, inside the opening of the carrying handle. The wing nut is firmly tightened until the tab is pulled tightly against the carrying handle and bracket.

MOUNTING THE SCOPE TO THE BRACKET

INSTALLATION

The lock knobs of the boresight mount assembly are rotated forward until they come to bear on the pins located on the assembly. The mount assembly is moved onto the guide rail of the adapter bracket from the rear until positioned against the pin stop of the guide rail. The starlight scope is then locked to the weapon adapter bracket by rotating the two locking knobs of the bore sight mount assembly in a rearward direction.

ZEROING

MOVE THE RETICLE PATTERN IN THE DIRECTION OF THE IMPACT

The lens cap must be positioned over the objective lens during daylight. When zeroing in daylight, it may be necessary to cover one or two of the small pinholes in the lens cap to reduce the amount of light entering the starlight scope. Provisions should be made to permit the sniper to confirm his zero during the hours of darkness without the lens cap. This will ensure the zero is maintained when one or more holes in the lens cap are covered.

Difficulty may also be experienced when attempting to zero the starlight scope just prior to daylight or just prior to darkness. The light level during this time is too low to permit the image intensifier tube to resolve the target with the lens cap in place; however, it is intense enough to cause the intensifier tube to automatically cut off when the lens cap is removed from the objective lens.

For this zero, the sniper must:

- Know the rear sight setting of his weapon for a particular range.
- Mount the starlight scope and place the weapon into a stable rest.
- Sight through the sight of the weapon (not the starlight scope) and align the sight on the target.
- Without disturbing the lay of the weapon and scope, sight through the scope; adjust elevation and windage on the starlight scope until the "T" reticle is aligned on the same point of aim as the sights of the rifle.

When the reticle and rifle sights are aligned to the same point of aim, the starlight scope and weapon are zeroed for that range. The sniper should fire a few rounds to confirm the zero.

The starlight scope may be zeroed during the hours of daylight, dawn and dusk, or darkness. When making adjustments for errors in elevation or windage, the sight, or reticle, must be moved in the direction of the error, or impact.

ZEROING DURING DAYLIGHT

ZEROING DURING DAWN OR DUSK

STABLE REST ZEROING

25-METER ZERO

Impact at 25 meters must be 1 inch below and 2½ inches right of target for a 150-meter zero.

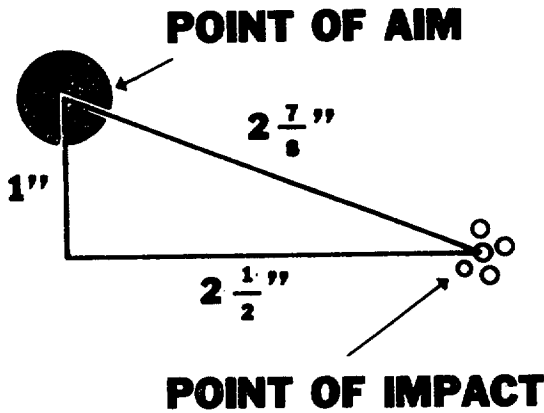

Figure 2-26. 25-Meter Zero.

This method requires the use of an observer to spot the strike of the bullet and give the correct sight changes to bring it to the point of aim.

The sniper and observer pick out a target that provides a definite point of aim and one that will show the strike of the bullet. This can be a brick building, dirt hillside, or any such surface.

Place the aiming reticle at the point of aim and fire one round. The observer estimates the distance between strike of the bullet and the aiming point and gives the change necessary to bring it to the point of aim. At 150 meters, the correction of an impact 2 feet high and 3 feet right of the aiming point would be up 8 clicks (24 inches) and right 12 clicks (36 inches). These adjustments are made and a confirming round is fired.

EMPLOYMENT OF STARLIGHT SCOPE

From a distance of 25 meters or 1,000 inches from the target, center the sight reticle on the target and fire a 3-round group.

From the center of the group, measure the distance to the proper point of impact.

Adjust the sight by moving the elevation and windage knobs until the impact is 1 inch below and 2½ inches right of the aiming point. "1 click" will move the strike of the bullet ¼ inch at 25 meters.

The adjustment of the reticle is moved toward the impact of the bullet.

Sight settings obtained at 25 meters should be confirmed by firing at the actual range of 150 meters.

FIELD EXPEDIENT ZERO

The function of the starlight scope is to provide an efficient viewing capability during the conduct of night combat operations.

Although the starlight scope does not give the width, depth, or clarity of daylight vision, the individual can see well enough at night to aim and fire his weapon and observe its effect.



Figure 2-27. Sniper Team.

The starlight scope may also be used to:

- Assist teams in deployment under the cover of darkness to preselected positions.
- Assist in movement to alternate positions undetected.
- Locate and suppress hostile fire.
- Limit or deny enemy movement at night.
- Counter enemy sniper fire.
- Demoralize the enemy with one-shot kills at night.

**FACTORS AFFECTING
EMPLOYMENT**

The effectiveness of the starlight scope will depend on:

**LIGHT LEVEL
WEATHER CONDITIONS
DENSITY OF TERRAIN
EYE FATIGUE**

LIGHT. The starlight scope functions using ambient light of the night sky. Effective operation may be expected with

**USE OF FLARES AND ILLUMINATION TO THE FLANKS
BRIGHT MOONLIGHT AND STARLIGHT
SEARCHLIGHTS**

Clarity of vision is better with a starlight scope than with the naked eye under illumination. As the ambient light decreases, the viewing capabilities decrease, such as on a dark, overcast night.

WEATHER CONDITIONS. Clear nights provide the most favorable operating conditions, though limited viewing capabilities may be possible in sleet, snow, smoke, or fog conditions.

EVALUATION OF TERRAIN

- When viewing from open terrain into densely wooded terrain, penetration of the wood line is limited to a few yards. Also, targets against a very dark background are difficult to detect.
- When viewing into sparsely wooded terrain under moon or starlight conditions, penetration is greatly improved depending on the depth of the woods, location of the moon, and range.
- When viewing from wooded terrain into open terrain under moonlight, viewing capabilities are excellent. Care must be taken not to limit the field of view with trees.
- When moving through densely wooded terrain under all conditions, viewing capabilities may be limited to a few meters.
- When moving through sparsely wooded terrain under moonlight, viewing capabilities are good, though depth perception may be difficult with the magnification of objects by the starlight scope.
- Little difficulty should be experienced in following trails or roads under moonlight conditions.
- Viewing across rivers, streams, or lakes under moonlight provide excellent viewing with the reflection of light off the water.

EYE FATIGUE. The starlight scope will cause eye fatigue in most operators after 5 or 10 minutes of continuous observation. With practice, an observer will be able to look through the starlight scope for longer periods of time. To lessen eye fatigue, alternating eyes during the viewing will help.

REMINDERS

The starlight scope can still be used for a short time after the power switch has been turned off. This will help conserve battery life.

If the rubber eyeshield is not positioned around the eye and against the face, light can leak around the eyeshield and illuminate the sniper's face.

MAINTENANCE

The sniper must perform the following preventive maintenance services daily to ensure the proper functioning of the starlight scope:

- Inspect and service main housing of starlight scope for dents, cracks, or loose or missing parts. Tighten loose parts. Report missing parts or damaged main housing to organizational maintenance.
- Inspect and service objective and focal lenses for dirt, dust, cracks, scratches, and signs of fogginess or moisture. If lenses are scratched, cracked, or fogginess or moisture appears within either lens assembly, report condition to organizational maintenance.
- Inspect range focus ring for dirt, free operation, or damage. Clean the focus ring; report faulty operation of focus ring or range ring to organizational maintenance.
- Inspect the azimuth and elevation adjustment knobs for dirt, damage, and freedom of operation. Clean dirty knobs. Report faulty operation to organizational maintenance.
- Remove battery cap from battery housing and inspect for dirt, cracks, dents, and damaged battery spring, or O-ring. Inspect battery for corrosion, leaks, and other damage. Install new battery, if necessary, and reassemble battery cap.
- Inspect exterior of oscillator cap for dirt, cracks, and dents. DO NOT remove oscillator cap from oscillator housing. Clean outside surfaces only. Report damaged oscillator cap to organizational maintenance.
- Although the operator is not authorized to remove the oscillator cap, it is possible to check the functioning of the oscillator. Move the control switch to the "on" position and listen for the operating hum which is audible if oscillator is working. If operating hum cannot be heard, report condition to organizational maintenance.
- With control switch in the "on" position, look into the eyepiece and inspect for operation of the image intensifier tube. DO NOT attempt removal of the image tube from the main housing. Return control switch to the "off" position. Report all failures or malfunctions of image tube to organizational maintenance.
- Inspect boresight mount assembly for cracks, breaks, dents, dirt, and operability of locking knobs. Service and replace as required.
- Inspect rubber eyeshield for dirt, oil, cracks, flexibility, and other damage. Clean with a clean wet cloth. Replace damaged eyeshield and assemble new eyeshield onto eyepiece assembly.
- Ensuring the control switch is in the "off" position, remove the lens cap and inspect for dirt, obstructed holes, cracks, or other damages. Clean with wet cloth and reassemble to objective lens assembly. Replace damaged lens cap and reassemble.

206. CARE AND CLEANING OF RIFLE AND EQUIPMENT

The sniper candidate, already an expert marksman, will be well aware of the benefits of keeping his equipment in a state of perfect repair and cleanliness. Nevertheless, his sniper training program must include a review of basic maintenance procedures and must stress the maintenance requirements for the special conditions he will encounter aboard ship, in weather extremes, and in combat. Additionally, he must be taught the methods for cleaning and safeguarding his sniper optical equipment.

RIFLE MAINTENANCE

Rifle maintenance is any measure taken to keep the weapon in top operating condition. It includes inspection, repair, cleaning, and lubrication.

Inspection reveals the need for repair, cleaning, or lubrication. A weapon, sheltered in garrison and infrequently used, must be inspected often to detect dirt, moisture, and signs of corrosion, and it must be cleaned accordingly. A weapon in use and subject to the elements, however, requires no inspection for cleanliness, since the fact of its use and exposure is sufficient evidence that it requires repeated cleaning and lubrication. The sniper couples his daily cleaning chores, however, with a program of minute inspection for damage or defect.

INSPECTION

The sniper, himself, can accomplish only the most superficial repair tasks, such as screw tightening or replacement. He has no disassembly authority (except that he may strip the bolt to clean and lubricate it), nor does he have a required variety of tools or parts. Field repair of the rifle is the responsibility of the rifle team equipment (RTE) repairman.

REPAIR

CLEANING THE RIFLE

TOOLS AND MATERIAL

- Cleaning patches.
- Dry cloths.
- Bore cleaner fluid. Fluid is used for cleaning both bore and chamber; it also temporarily inhibits rust.
- Hot soapy water or plain hot water. Water is a poor substitute for bore cleaner fluid but should be used when bore cleaner is not available.
- Cleaning rod. A cleaning rod is used in cleaning the bore and chamber. Soft metal rods of brass or aluminum are superior to hard steel rods, which may cause excessive wear on the lands, especially at the muzzle.
- Bore brushes (.30 and .45 calibers)
- Soft bristle paintbrush.
- Stiff or brass bristle scrub brush.

WHEN TO CLEAN THE RIFLE

BEFORE FIRING. The rifle must always be cleaned prior to firing. Firing a weapon with a dirty bore or chamber will multiply and speed up any corrosive action which may have begun. Oil in the bore and chamber of even a clean rifle will cause pressures to vary and first-round accuracy will be lost. In combat, the sniper will clean and dry the bore and chamber prior to departure on a mission and will be extremely careful to keep his rifle clean and dry en route to his objective area. Firing a rifle with oil or moisture in the bore will cause a puff of smoke that can disclose the sniper's position.

AFTER FIRING. The rifle must be cleaned after it has been fired, because firing produces deposits of primer fouling, powder ashes, carbon, and metal fouling. Although modern ammunition has a noncorrosive primer which makes cleaning easier, the primer still leaves a rust if not removed. The rifle must be cleaned within a reasonable interval—a matter of hours—after cessation of firing. Common sense should preclude the question as to the need for cleaning between rounds. Repeated firing will not injure the weapon **IF IT WAS PROPERLY CLEANED BEFORE THE FIRST ROUND.** After a rifle has been fired, it must be cleaned daily for at least 3 consecutive days. For several days after that, it must continue to be checked for fouling by running a clean patch through the bore.

CLEANING PROCEDURES

- Assemble the brass cleaning rod with a bore brush on the end.
- Lay the rifle on a cleaning table or other flat surface with the muzzle away from the body and the sling down. Make sure you do not strike the muzzle or telescopic sight on the table.
- Always clean the bore from the chamber toward the muzzle:
 - With the bore brush, push the brush all the way through until it protrudes from the muzzle, then pull it back **SLOWLY** until it clears the chamber.
 - Run the bore brush through a **MINIMUM** of 20 times.
 - While cleaning, keep the muzzle lower than the chamber to prevent bore cleaner from running into the receiver or firing mechanism. Be careful not to get any type of fluid between the receiver and the stock. If fluid does get between the stock and receiver, the receiver will actually "slide" on the glass bedding every time the rifle recoils, thereby decreasing accuracy and increasing wear and tear on the receiver and glass bedding.
- Using a section of the cleaning rod and a .45 caliber bore brush, clean the chamber by rotating the brush 8 to 10 times. **DO NOT** scrub the brush in and out of the chamber.

- Reassemble the cleaning rod with a swab holder attached. Insert a clean patch and run the patch through the bore. Change patches and continue the process until a patch comes out clean.
- Using the same procedure for cleaning the chamber, wrap a patch around the .45 caliber bore brush and rotate four or five times (in the chamber). Change patches and continue the process until a patch comes out clean.
- Finally, with a clean patch, apply a very light coat of cleaning solvent to the bore and chamber.

BOLT. Scrub the face of the bolt with the stiff bristle brush. Remove the grease, oil, and dirt from the bolt with a clean, dry cloth. In lubricating the bolt, put a light coat of rifle grease (if available) on the face and slides of the bolt.

STOCK. Since the M40A1 sniper rifle has a fiberglass stock, the only cleaning that is required is to use a clean rag with soap and water. Then, dry thoroughly to prevent moisture from accumulating beneath the receiver.

BARREL (Outside). Since the barrel is stainless steel, outer lubrication is not absolutely necessary.

OTHER PARTS. All metal parts are "blued" in manufacturing but still require lubrication, especially if scratched or if the bluing has rubbed off. Use a toothbrush to remove excessive grease, oil, and dirt. Use the soft-haired paintbrush to dust out recesses and to remove lint. Lubricate accordingly.

LUBRICATING THE RIFLE. All moving parts of the rifle should be lubricated with rifle grease or something similar.

NEVER REMOVE THE TORQUE SCREWS

THIS IS DONE BY A QUALIFIED RIFLE TEAM EQUIPMENT REPAIRMAN (MOS 2112). IF ANYTHING MALFUNCTIONS ON THE RIFLE, NEVER TRY TO REPAIR IT YOURSELF. ALWAYS TRY TO LOCATE A RIFLE TEAM EQUIPMENT REPAIRMAN.

OPTICAL EQUIPMENT MAINTENANCE

Dirt, rough handling, or abuse of optical equipment will result in inaccuracy and malfunction. When not in use, the rifle and scope should be cased, and the lenses should be capped.

Lenses are coated with a special light-gathering material (HELIR). The coat is a very thin and great care is required to prevent damage to it.

CLEANING THE LENSES

- To remove dust, lint, or other foreign matter from the lens, brush it lightly with a clean camel hair brush.
- To remove oil or grease from the optical surfaces, breath heavily on the glass and clean it with lens tissue. In field use, where tissue may not be available, a soft clean cloth may be substituted.

Telescopes are delicate instruments and must be handled with care. The following precautions will prevent damage:

HANDLING TELESCOPES

- Check and tighten all mounting screws periodically and always prior to leaving on an operation. Be careful not to change coarse windage adjustment.
- Keep lenses free from oil and grease and never touch them with the fingers. Body grease and perspiration injure them. Keep lenses capped.
- Do not force elevation and windage screws or knobs.
- Do not allow the telescope to remain in direct sunlight, and avoid letting the sunrays shine through the lens. Lenses magnify and concentrate sunlight into a pinpoint of intense heat which is focused on the mil scale reticle. This may melt the mil dots and damage the telescope internally. Keep the lenses covered and the entire telescope covered when not firing or observing.
- Avoid dropping the scope or striking it with another object. This could damage the scope severely and permanently, plus change the zero.

TO AVOID DAMAGE TO THE SCOPE OR ANY OTHER SNIPER EQUIPMENT, THE SNIPERS OR RIFLE TEAM EQUIPMENT ARMORERS SHOULD BE THE ONLY PERSONNEL HANDLING THE EQUIPMENT. ANYONE WHO DOES NOT KNOW HOW TO USE THIS EQUIPMENT PROPERLY COULD CAUSE DAMAGE.

MAINTENANCE AND CARE IN COLD CLIMATE

RIFLE

In temperatures below freezing, the rifle must be kept free of moisture and heavy oil, both of which will freeze, causing working parts to freeze or operate sluggishly. The rifle should be stored in a room with the temperature equal to the outside temperature. If the rifle is taken into a warm area, condensation will occur, thus requiring a thorough cleaning and drying before being taken into the cold. Otherwise, the condensation will cause icing on exposed metal parts and optics.

OPTICAL EQUIPMENT

In extreme cold, care must be taken to avoid condensation and the congealing of oil on the glass.

- If not excessive, condensation can be removed by placing the instrument in a warm place. Concentrated heat must not be applied, because it will cause expansion and damage. Moisture may also be blotted from the optics with soft, dry cloths.
- In cold temperatures, oil will thicken and cause sluggish operation or failure. Focusing parts are particularly sensitive to freezing oils. Breathing will form frost, so the optical surfaces must be cleaned with lens tissue, preferably dampened lightly with alcohol. Do not, however, apply the alcohol directly to the glass.

MAINTENANCE AND CARE AFTER SALT WATER EXPOSURE

RIFLE

Salt water and salt water atmosphere have extreme and very rapid corrosive effects on metal. During periods of this exposure, the rifle must be checked frequently and cleaned as often as possible, even if it means only lubricating the weapon. The weapon should always be well lubricated, including the bore, except when actually firing. Before firing, always run a dry patch through the bore, if possible.

MAINTENANCE AND CARE DURING JUNGLE OPERATIONS (High Humidity)

RIFLE

- Use more lubricant.
- Keep rifle in case when not in use.
- Protect from rain and moisture whenever possible.
- Keep ammunition clean and dry.
- Clean rifle, bore, and chamber daily.
- Keep scope caps on scope when not in use. If moisture or fungus develops inside scope, get replacement scope.
- Clean and dry the stock daily.
- Dry the carrying case and rifle in the sun whenever possible.

- Use less lubricant and preservative oil due to the fact that oil collects sand and dust.
- Keep rifle free of sand by use of a carrying sleeve or the case when not in use.
- Keep the sight protected from the direct rays of the sun.
- Keep ammunition clean and protected from the direct rays of the sun.
- Use a toothbrush to remove sand from the bolt and receiver.
- Clean the bore and chamber daily.
- Protect the muzzle and receiver from blowing sand by covering with a clean cloth.

To protect the free-floating barrel of the weapon, *take an 8- or 9-inch strip of cloth and tie a knot in each end. Then, before going on a mission, slide the cloth between the barrel and stock all the way to the receiver and leave it there.* When in your firing position, slide the cloth out, thus taking all restrictive debris and sand with it.

Optics are especially vulnerable to hot, humid climates and salt water atmosphere.

Sunrays. Optical equipment must NOT be exposed to direct sunlight in a hot climate.

Humidity and Salt Air. In these environments, the optical instruments must be inspected and cleaned frequently to avoid rust and corrosion. A light film of oil is beneficial.

Perspiration. Perspiration from the hands is a contributing factor to rusting. After being handled, instruments must be thoroughly dried and lightly oiled.

MAINTENANCE AND CARE, DESERT OPERATIONS

RIFLE

MAINTENANCE AND CARE, HOT CLIMATE AND SALT WATER ATMOSPHERE

OPTICAL EQUIPMENT



SECTION 3

MARKSMANSHIP TRAINING

301. PURPOSE

The purpose of sniper marksmanship training is to teach the sniper the principles and techniques of precision shooting with special sniper equipment.

302. FUNDAMENTALS

Rifle marksmanship fundamentals are those basic factors that must be practiced constantly in order for a shooter to deliver accurate hits on a target, to effectively provide support for his rifle, to correctly align his sights on a target, and finally, to fire without disturbing his sight alignment.

303. PROGRESSIVE TRAINING

Effective training in fundamentals can be provided by a six step program involving the following sequence of instruction:

- Sighting and Aiming. The proper relationship between the eye, rifle sights, and target.
- Positions. Proper applications of all sniper positions.
- Trigger Control. Firing a rifle without disturbing the sights.
- Sight Adjustment. Proper manipulation of sights to regulate the strike of the bullet.
- Weather Effects. How weather conditions affect the sniper and the bullet and how to compensate for those conditions.
- Zeroing. Adjusting sights to hit a given target at a given range. How to bore sight a new scope.

304. SIGHTING AND AIMING

General. The arrangement of an optical sight allows aiming without the use of a front and rear sight. The role of a front sight in a telescope is filled by the crosshairs. The image (target) and crosshairs are on the same line of sight.

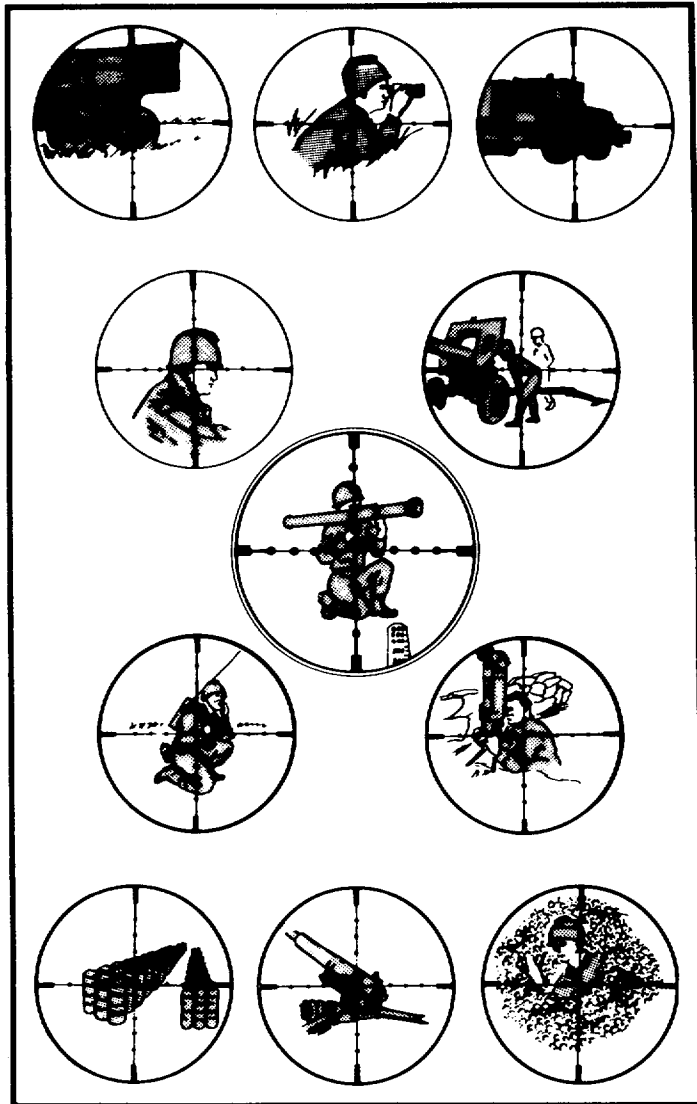

Figure 3-1. Sight Pictures.

The sniper sees the crosshairs and the image (target) at the same time. Both crosshairs and target have the same degree of clarity. The sniper's head must be placed at the exit pupil of the telescope. He then positions his head so that he has a full field of view with no shadows, places the crosshairs on the target, and *QUARTERS* the target.

Exit Pupil. The small circle of light seen coming from the eyepiece lens when a scope is held at arms length.



Figure 3-2. Quartering the Target.



Figure 3-3. Eye Relief.

EYE RELIEF

In aiming, the eye must be located straight to the rear of the scope. A 2- to 3-inch distance is average. The sniper adjusts his eye relief to ensure a full field of view. It may be a fairly large distance, but it is necessary to ensure safety from recoil.

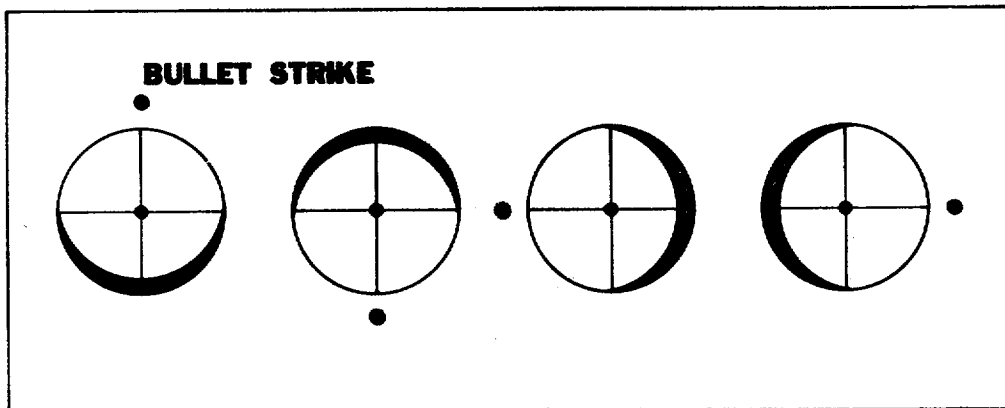

Figure 3-4. Shadow Effects.

SHADOW EFFECTS

During aiming, the sniper must ensure that there are no shadows in the field of view of the telescope. The field of view must be completely clear. If the sniper's eye is located without proper eye relief, a circular shadow will be seen in the field of view, reducing the field size and hindering observation. If crescent-shaped shadows are present, the bullets will strike to the side away from the shadow.

If the sniper notices shadows on the edges of the field of view during aiming, he must find a position for his head in which his eye will see clearly the entire field of view of the telescope.

HEAD ADJUSTMENT

ADVANTAGES OF TELESCOPIC SIGHTS

The telescopic sights permit:

- Extreme accuracy in aiming, which enables the sniper to fire at distant, barely perceptible, and camouflaged targets which are not visible to the naked eye.
- Rapid aiming because the snipers' eye sees the crosshairs and the target with equal clarity, at the same time.
- Accuracy of fire under conditions of unfavorable illumination, such as at dawn and dusk and during periods of limited visibility (moonlight, fog, etc.).

CANTING

Canting is the act of tipping the rifle to either side of the vertical. If the horizontal crosshair is canted, the strike of the bullet will hit in the direction of the cant. The more the cant, the further off the target the strike of the bullet will be.

305. TRIGGER CONTROL

Trigger control is the skillful manipulation of the trigger by which the sniper causes the rifle to fire without disturbing the alignment of the rifle with the target.

GENERAL

The trigger finger should contact the trigger at some point between the tip and the second joint. The exact placement is a matter of individual preference and depends on the size of the sniper's hand and the manner in which he grips the stock.

FINGER PLACEMENT

During the firing process, a gradual increase of pressure is applied straight to the rear on the trigger insuring the crosshairs continue to quarter the target. The crosshairs cannot be held indefinitely on the point of aim; therefore, the sniper must practice to *stop* the finger pressure on the trigger when the crosshairs move off the point of aim. The sniper applies the remaining pressure when the crosshairs come to rest on the point of aim.

The upper part of the trigger finger should be kept clear of the stock to allow a front-to-rear movement in applying pressure on the trigger. When the finger touches the stock, there is a tendency to cause pressure at a slight angle rather than straight to the rear, this will cause the sights to be pulled off the aiming point. A *firm* grip on the rifle stock is essential for good trigger control. A loose grip tends to cause the hand and trigger finger to squeeze the stock and thus lose trigger control.

Trigger control is the most important steady hold factor. However, it is the most *difficult* fundamental to master. The majority of errors stem directly or indirectly from the improper application of this technique. Missing the point of aim frequently results from the shooter jerking the trigger or applying pressure on both the trigger and the side of the rifle. Improper trigger control can start a chain reaction of other errors.

Flinch. An involuntary muscular tension in anticipation of recoil. It is indicated by:

BAD HABITS

- Moving the head.
- Closing the eyes.
- Tensing the nonshooting arm.
- Moving the shoulders.
- Combination of these.

Buck. Moving shoulders forward as the rifle recoils.

Jerk. An attempt to make the rifle fire at an exact time by sudden pressure on the trigger thus disturbing the alignment of the rifle with the target.

Followthrough is the continued mental and physical application of the fundamentals after each round has been fired. The sniper does not shift his position, move his head, or let the muzzle of the rifle drop until a few seconds after the rifle has been fired.

FOLLOWTHROUGH

CALLING THE SHOT

The sniper calls his shot after the rifle is fired. Seeing the last sight picture as the rifle is fired, the sniper must make a determination as to where his sights were when the round broke. If he believes his shot to be at the aiming point and the shot is misplaced, the sniper could have violated one of the marksmanship principles. If the sniper is sure none of these fundamentals were violated, then a zero change is necessary. Calling the shot assists the sniper in constantly confirming his zero.

306. SHOOTING POSITIONS

GENERAL

A correct shooting position is essential to sniping. The more solid the position, the easier it is to hold the rifle and control the trigger without disturbing the sight picture.

RIFLE SLINGS

Leather slings are most used by snipers. The sling is constructed in two different lengths with two leather sling keepers to secure the sling once it is on the arm.

The leather sling is preferred over the web sling because of its strength and durability. It is easier to use once the sniper is taught the basic way to attach it to the rifle and how it is placed on the arm.

Another advantage of the leather sling is, once adjusted for a position, the adjustment need not be changed to tighten the sling on the rifle for carrying.

ELEMENTS OF A GOOD SHOOTING POSITION

The three elements of a good shooting position are:

BONE SUPPORT

MUSCULAR RELAXATION

NATURAL POINT OF AIM

Bone Support. A strong foundation is just as necessary to a rifle as to a well-built house. Good shooting positions employ bone support and not muscle support.

Muscular Relaxation. The sniper learns to relax in various shooting positions. Undue strain or tension causes trembling and is transmitted to the rifle. Through practice and natural point of aim, the sniper will be able to achieve muscular relaxation.

Natural Point of Aim. In a shooting position, once the target is spotted, the sniper closes his eyes, takes a deep breath, exhales, and concentrates on making his body completely relaxed. The rifle will fall to its natural point of aim. He opens his eyes and adjusts the position by slightly shifting his body until the rifle points to the target exactly where the bullet is to strike.

The five basic shooting positions used in sniper training are prone, sitting, kneeling, standing, and the Hawkins position. These positions are flexible to allow modifications according to the individual body structure. On the battlefield, a sniper must assume the steadiest position possible which will allow observation of the target area and provide cover and concealment. Depending on the terrain, vegetation, and tactical situation, there are innumerable possibilities; however, in most instances they will be variations of the five basic positions. Some snipers will have more difficulty in assuming a particular position than others. The sniper must apply the fundamentals of relaxation and maximum support for his rifle. He should be permitted to adjust the position to best fit his own body structure.

FORWARD HAND AND ELBOW

The palm of the forward hand is against the upper sling swivel. The wrist is straight and locked so that the rifle rests across the heel of the hand. The hand itself is relaxed. The fingers can be curled against but should not grip the stock, since the rifle should rest on the forward hand. The forward elbow should be directly under the receiver of the rifle, or as close to this position as the body will permit, with the forward elbow directly under the rifle. The bones (rather than the muscles) support the rifle's weight. The sniper, by trial and error, must find the forward hand and elbow position best suited to him to avoid tension and trembling.

RIFLE BUTT IN THE POCKET OF THE SHOULDER

The sniper places the rifle butt firmly into the pocket of the shoulder. The proper placement of the butt helps steady the rifle and prevents it from slipping out of the shoulder. With the rifle butt firmly in the shoulder, the recoil is lessened.

GRIP OF THE SHOOTING HAND ON THE RIFLE

The shooting hand grips the small of the stock firmly but not rigidly. A firm rearward pressure is exerted by the gripping hand to keep the rifle butt in its proper position in the pocket of the shoulder to reduce effects of recoil. The thumb lays on the small of the stock in its natural position, and also forms a rest for the chin. In this way it creates a spot weld. The trigger finger is placed on the trigger in a natural position to enable the shooter to manipulate his trigger independently of the rest of his hand. This permits the trigger to be squeezed directly to the rear without disturbing the point of aim.

REAR ELBOW

The placement of the rear elbow gives balance to the sniper's position. Correctly positioned, the elbow helps form the shoulder pocket. The exact location of the elbow varies with each position and will be described in the explanation of each position.

SPOT WELD

The spot weld is the point of firm contact between the sniper's cheek and thumb on the small of the stock. The firm contact between the head, hand, and rifle enables the head and weapon to recoil as one unit, facilitating rapid recovery between rounds. The spot weld also enables the eye to be positioned the same distance behind the eyepiece (eye relief) of the scope each time the rifle is aimed and fired. This guarantees the same field of view with each sight picture, further assisting in accurate aiming. If the sniper is unable to obtain a spot weld, he should use the stock weld.

FACTORS COMMON IN ALL POSITIONS



Figure 3-5. Spot Weld.



Figure 3-6. Stock Weld.

BREATHING

Normal breathing will cause the rifle to move while aiming and firing. To avoid this movement, the sniper holds his breath for a few seconds and, during this time, he should fire his round. He takes a normal breath, releases part of it, and holds the remainder. He should not hold his breath for over 10 seconds, because his vision may blur and lung strain may cause muscular tension.

SUPPORTED POSITIONS

These positions should be used extensively by snipers. The support or rest almost guarantees no movement of the rifle. The rest prevents muscular tension and pulse beat which is transmitted to the rifle, and throws the shot off target. The longer the range the steadier the rifle must be. Use of the supported positions allows a much lower silhouette and therefore offers more cover and concealment. There are four types of positions using the supported rest—prone, sitting, kneeling, and the Hawkins. These positions may be modified to fit the sniper's location, depending on the terrain, vegetation, and situation on the battlefield. When using a supported rest, the rest itself can be any material available, such as sandbags, logs, fencing, and even the partner's back.

PRONE

The prone position is the most common position used. The sniper rests his rifle on a solid object somewhere near the front sling swivel, making sure the rifle barrel is *NOT* resting on the support. If the barrel touches the support in any way, the accuracy of the weapon is greatly decreased. The nonshooting arm grasps the sling on the rear sling swivel, in this way the sniper can adjust the weapon on the target. With a firm hold on the rifle, the sniper places the stock into the pocket of the shoulder and applies rearward pressure into the pocket. The shooting hand is placed in the normal manner on the small of the stock; the sniper then makes his mental checklist.



Figure 3-7. Prone Position (Supported).

- Is the body directly behind the rifle to better absorb recoil?
- Is the nonshooting hand grasping the sling and rear swivel with a firm pressure towards the pocket of the shoulder?
- Does the sniper have proper eye relief? Does the sniper have full field of view in scope?
- Is the grip on small of stock firm? Is trigger finger applying pressure straight to the rear?
- Is the sniper breathing so that crosshairs are moving from 12 o'clock to 6 o'clock (straight up and down)?
- Are the crosshairs quartering the target?

This position is one in which the sniper can modify for use behind any cover which provides a platform on which his rifle can be rested. The sniper must be careful not to rest the barrel of the rifle in any way on the support as this could affect accuracy.

SITTING

Kneeling positions are used when the position has to be higher to shoot over an obstacle. The rifle is supported on a rest, making sure rest is not touching the barrel. The nonshooting hand may be placed on the leg to ensure a solid position.

KNEELING



Figure 3-8. Sitting Position (Supported).



Figure 3-9. Kneeling Position (Supported).



Figure 3-10. Hawkins Position.

The Hawkins position is used when a low silhouette is desired, such as when shooting on flat ground, off a roof, or down grade. The position is the same as the prone, except the support is provided by the nonshooting hand. The sniper assumes a prone position, slides his nonshooting hand up to the front sling swivel, and grasps the sling firmly. The wrist and elbow are *locked* straight. This takes up most of the recoil. The rear, or toe of the stock is placed under the armpit and rests on the ground if possible. It will appear that the sniper is lying on the rifle.

HAWKINS



Figure 3-11. Rifle being Carried.



Figure 3-12. Rifle in Position.

307. M16 QUICK KILL METHOD

The rifle is carried in a position that allows the partner to get a shot off in less time than if he was carrying the rifle at port arms.

When the rifle is raised to shoot, the eye is looking at the target. As the sniper looks at his target, the front sight comes into view, and at that same moment the shot is fired without actually looking for a sight picture.



Figure 3-13. Observer Sniper Positioning.

308. OBSERVER, SHOOTER POSITIONING

When the sniper and observer are operating together in position, the observer should be close to the sniper's right side (if a right handed shooter) to be able to converse with him in a low voice. The team should be close to each other so both members can look on a single range card or map. The observer should also be in a position to watch the vapor trail of the bullet down range. This will help the observer spot the splash of the impact of the round to give the sniper a correction for his next shot, if it is needed.

309. ZEROING

PRINCIPLES OF ZEROING

BULLET PATH AND POINT OF AIM

To understand the principles of zeroing, the sniper should have a basic knowledge of the relationship between the path of the bullet and line of aim. A bullet does not follow a straight line, but travels on an arc which is called the bullet's trajectory.

DEFINITION OF ZERO

The zero of a rifle is the sight setting in elevation and windage required to place a shot in the center of a target, at a given range, when no wind is blowing.

CONDUCT OF BORESIGHTING

Boresighting with Unertl sniper scope is conducted only in respect to coarse windage adjustment.

The sniper first must insure that:

- The *elevation* range knob is turned to 3.
- The elevation *fine* tune knob is at 0.
- The *windage* knob is at 0.

With the bolt removed from the rifle, the rifle is placed on a solid support such as a sandbag or an ammo can.

Looking through the barrel (at the chamber end), the sniper adjusts the rifle until the desired aiming point is visible through the center of the bore.

Without disturbing the lay of the rifle, he looks through the telescope and observes the position of the crosshairs in relation to the aiming point. If the crosshairs do not coincide with the aiming point, he loosens the rear mounting screws on the scope mount. He turns the screws to move the scope left or right, depending on the direction the crosshairs need to go.

Example: To move the crosshairs (vertical) onto the aiming point, he looks through the scope, turns the left screw against the scope mount to push the rear of the scope right. The crosshairs will be moving to the left.



Figure 3-14. Course Adjustment with Scope Base for Zeroing.

Zero scope as follows: Set range knob to "3" (300 yards). Set windage and elevation vernier to "0". Fire a group at 300 yards. If the point of aim/point of impact difference is greater than 12 feet (assuming center allen screws are set as received from factory; i.e., elevation screw .035 inches below knob surface and windage screw .035 inches below surface), the scope mounting should be adjusted. Approximately .001 inch change in one end of mount will change point of aim/point of impact distance by 1 foot. The mount base should be milled as required to bring the elevation to within 12 minutes. Windage should be adjusted to as close to "0" as possible using the rear mount windage adjusting screws (course adjustment).

Final zeroing may now be done using the allen screws in the center of the elevation and windage knobs. Loosen set screws and carefully adjust large allens until point of aim and point of impact are coincident. No more than + or - $\frac{1}{4}$ turn should be required if mounting has been adjusted as described above. After scope is zeroed, *securely* tighten set screws. The rifle should now shoot point of aim/point of impact at all ranges from

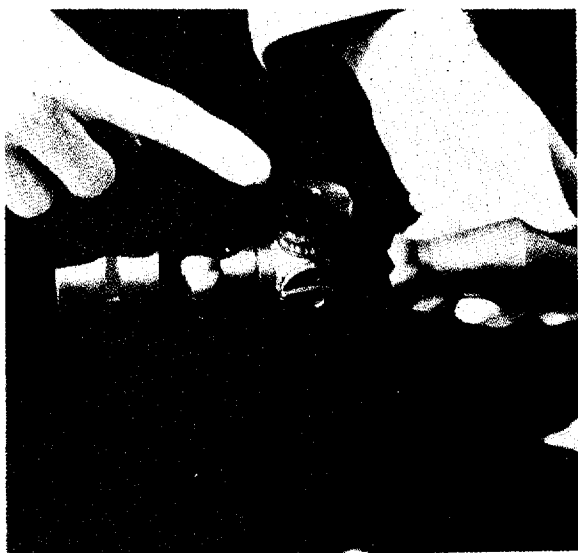

Figure 3-15. Zeroing with Allen Wrench Elevation Control (View 1).

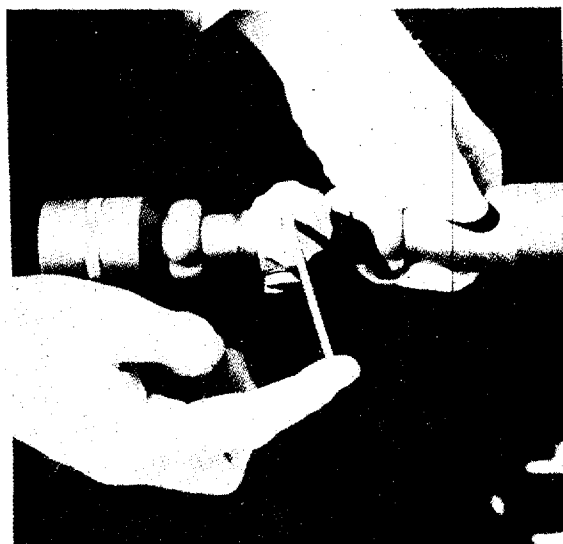

Figure 3-16. Zeroing with Allen Wrench Elevation Control (View 2).

100 to 1,000 yards when the range knob is set to the corresponding range. Windage may be adjusted + or -4 minutes (via fine tune knob) as needed. Elevation may be adjusted + or -3 minutes as needed to compensate for temperature and other variables, using the elevation fine tune knob.

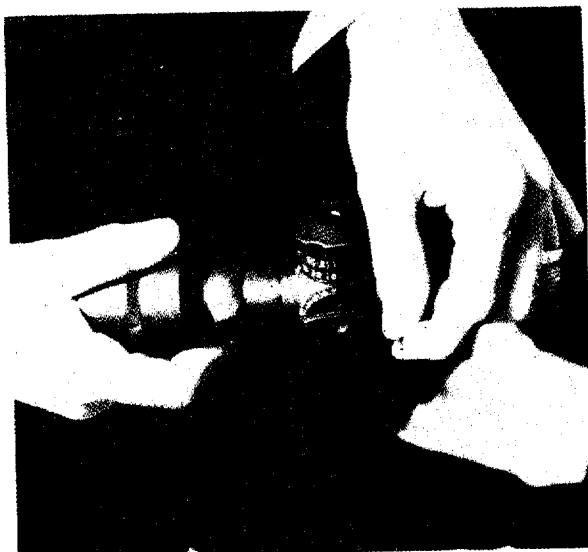

Figure 3-17. Zeroing with Allen Wrench Windage Control (View 1).

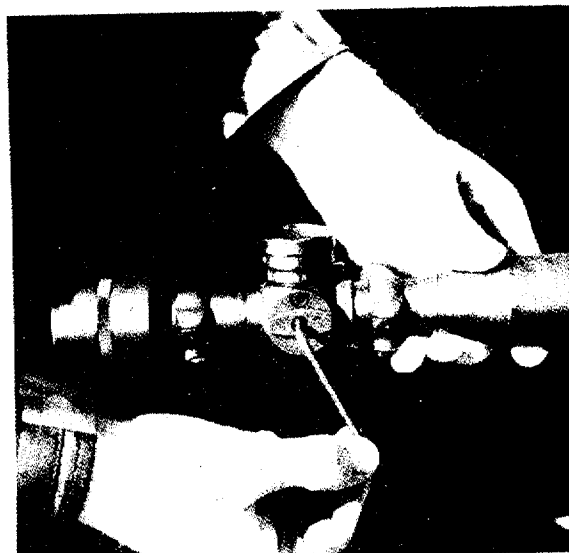

Figure 3-18. Zeroing with Allen Wrench Windage Control (View 2).

310. EFFECTS OF WEATHER

Wind, light, temperature, and humidity all have some effect on the bullet, the sniper, or both. Under average conditions, some weather effects, such as temperature and humidity, are insignificant. Sniping sometimes is done in extremes, so all effects must be considered.

Wind is usually the greatest weather problem. As wind velocity increases, the effect on the bullet increases, depending on the wind direction and/or as the range increases.

Winds are classified according to the direction from which they are blowing.

CLOCK SYSTEM

The clock system is used to determine what direction and what force or velocity the wind is blowing. This is known as the value of the wind. With use of a formula, a sniper can adjust his scope to compensate for the wind and to hit center.

A 9- to 3-wind has the most effect on a bullet. This is the full value wind.

WIND

CLASSIFICATION OF WINDS

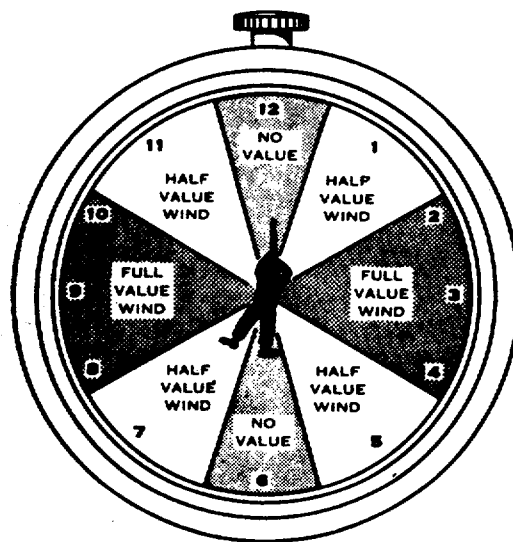

Figure 3-19. Clock System.

There are three common field expedient methods of approximating wind speed. Due to the snipers situation, all three should be learned.

WIND VELOCITY

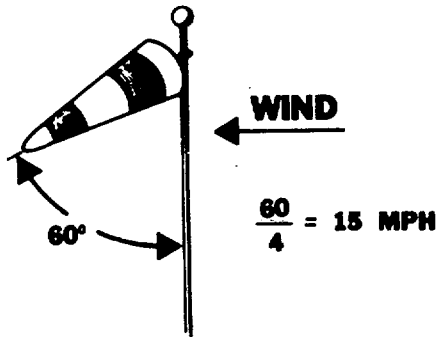

Figure 3-20. Flag Method.

FLAG METHOD

If a sniper can observe a flag or cloth like material hanging from a pole and estimate the degrees from the tip of the flag to the mast, he can estimate wind velocity. He divides the constant number 4 into the number of degrees to get wind velocity in miles per hour.

If the tactical situation prevents the use of the other methods, snipers can use the following guides:

- A wind under 3 miles per hour can hardly be felt, but causes smoke to drift.
- A 3- to 5-mile per hour wind is felt lightly on the face.
- A 5- to 8-mile per hour wind keeps tree leaves in constant motion.
- An 8- to 12-mile per hour wind raises dust and loose paper.
- A 12- to 15-mile per hour wind causes small trees to sway.

OBSERVATION METHOD

The M49 spotting scope can be used to "READ" THE WIND. THIS IS DONE BY OBSERVING THE "MIRAGE". The sun heats up the earth's surface causing heat waves in the same manner as a piece of metal does. These waves appear to ripple or shimmer and rise straight up from the ground on a calm day. Any movement of air, however slight, will send these waves in the direction of the air flow. This mirage is clearly seen on a bright clear day. To see this mirage through an M49 spotting scope, the sniper will first focus on an object somewhere close to his target. He then rotates the eye piece $\frac{1}{4}$ turn *counterclockwise*. This causes the actual focus to be short of the target, but the mirage is seen clearly.

SPOTTING SCOPE METHOD

By determining whether the waves appear to be slow or fast and from left or right, the sniper will be able to determine wind velocity and wind direction. Only after constant use can a sniper become proficient in determining how much windage adjustment to put on his rifle.

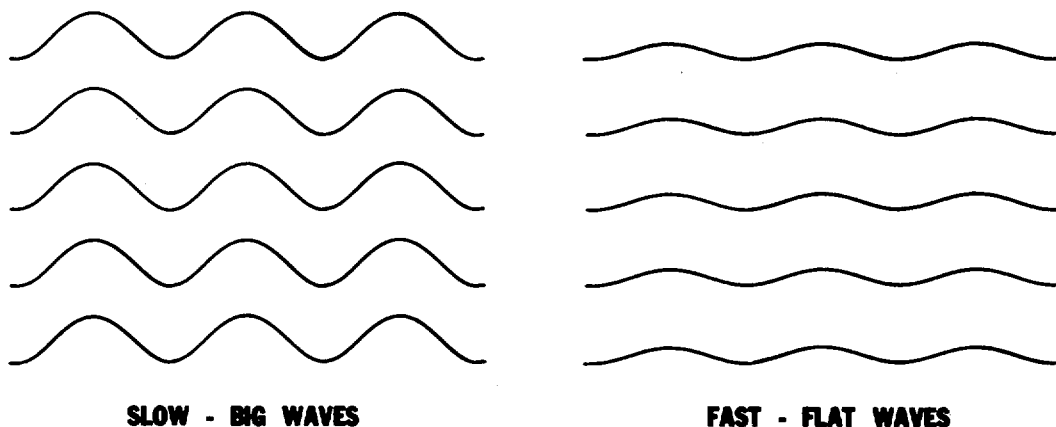

Figure 3-21. Mirage.

After finding wind direction and velocity, the windage correction is determined by the formula:

$R \times V$ divided by 15:

R=Range in hundreds of yards

V=Wind velocity in miles per hour

15 is a constant number.

For $\frac{1}{2}$ -value winds divide the answer to the above formula by 2.

This formula is accurate up to 500 yards. Beyond 500 yards, it varies due to bullet velocity loss. However, by changing the constant "15" as follows, the correct windage may be determined:

600 yards, divided by 14

700 yards, divided by 13

800 yards, divided by 13

900 yards, divided by 12

1,000 yards, divided by 11

Only by considering all the effects of weather, can a sniper recognize which is his most immediate problem. Proper recording on a daily basis while shooting is most important. If a change is indicated, it should be applied to all ranges.

**DETERMINE
WINDAGE
ADJUSTMENT**

311. HOLDS AND LEADS

Holds and leads are advanced techniques of marksmanship that enable the sniper to hit his target without holding his crosshairs directly on the target.

HOLDS

With the USMC scope, the only holdoff on a target would be a windage holdoff. When the sniper has determined what the wind is blowing and has adjusted his sights accordingly, he then may have to hold off right or left of the target slightly, depending on the "pick up" or "let off" of wind blowing. Constant practice in wind estimating can bring about proficiency in sight adjustment or learning to "holdoff" correctly.

Holding for elevation or wind are techniques used only when snipers do not have time to change sight settings. Pinpoint accuracy is rarely achieved when holding, since a minor error in range estimation, or lack of a precise aiming point, might cause the bullet to miss the desired point. However, a hit anywhere on the body is normally disabling, so a small error is acceptable in combat.

HOLDOFF

LEADS

The angle of movement an enemy is walking is important, in that the holdoff for different angles change the amount of lead on the target.

Moving targets are the most difficult to hit. When engaging a target which is moving straight (3 to 9 o'clock, 9 to 3 o'clock) across his line of sight, the sniper must concentrate moving his sight with the target, or with practice, using the "ambush" method. This is holding the crosshairs still and waiting for the target to move into the desired point, at which time, the sniper fires and lets the target walk into the bullet.

ANGLE OF TARGET MOVEMENT

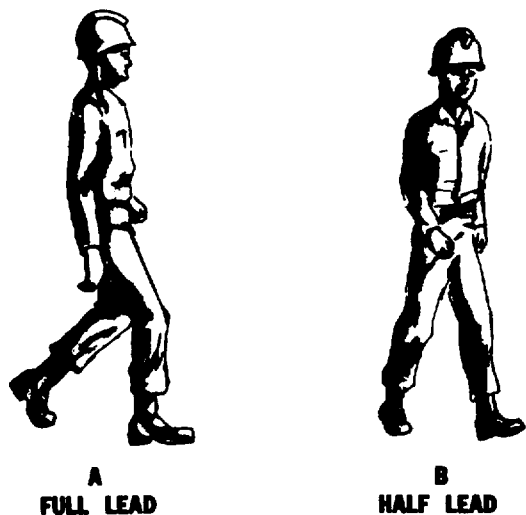

Figures 3-22 A and B show *FULL LEAD*. One arm and side are visible.

A *HALF LEAD* is when two-thirds of the front or back are visible. The half lead target is moving at an angle of approximately 45 degrees from the sniper.

Figure 3-22. Determining Angle of Movement.
(Full Lead and Half Lead)

A no lead target occurs when the entire back or the front of the target is visible. The target is moving directly toward or away from the sniper. These are straight away shots.

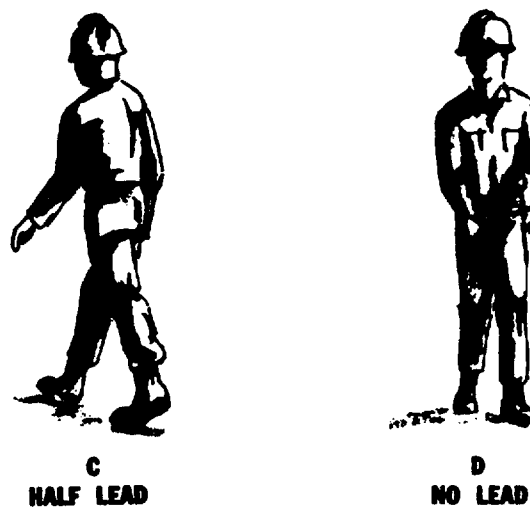

Figure 3-23. Determining Angle of Movement.
(Half Lead and No Lead)



SECTION 4

FIELD SKILLS

401. TARGET DETECTION AND SELECTION

The sniper's mission requires him to:

GENERAL

- Support combat operations.
- Deliver precise fire at selected targets.
- Be concerned with the significance of a target.
- Index the location and identification of his target.
- Fire in the order of target priority.

Though it is possible to come across targets of opportunity while on the move, the sniper should not rely on these as primary targets. The proper method is to select a specific area for observation, move to that area under cover of darkness, and set up in a well-concealed position. This position should have:

SNIPING POSITION

- Good fields of observation.
- Prearranged escape route.
- Security to the rear.

SEARCHING

The sniper team should be in position by first light. Initially, a HASTY SEARCH is conducted to detect enemy in the immediate area. Once this is done, a DETAILED SEARCH is conducted over the entire area.

This is where the art of observation comes into play. Every minute object is studied and identified for possible evidence of the enemy.

INDEXING TARGETS

The sniper team must have an accurate method of relaying the locations of possible targets to one another. The following is a conversation between a sniper and an observer:

OBSERVER:	"I see something over there."
SNIPER:	"Over where?"
OBSERVER:	"Way over there to the right."
SNIPER:	"Where to the right?"
OBSERVER:	"Beside that big tree."
SNIPER:	"Which tree?"

It is easy to see how ineffective this team would be. The indexing of targets prevents confusion and provides a quick reference guide. This is a conversation with the targets indexed:

OBSERVER:	"Target, Sector A, barn door, 800 meters."
-----------	--

METHODS OF INDICATING TARGET POSITIONS

PROMINENT OBJECTS and TERRAIN FEATURES are drawn on the sniper's range card with the individual distances. A target can be spotted quickly by its relation to one of the prominent features on the card. The following are methods of indicating the position of possible targets:

- Use of the mil scale on binoculars.
- Hasty methods such as the width of the hand, fist, or fingers held at arm's length; e.g., "Three fingers left of the dead tree."

NUMBER OF TARGETS

If the sniper is unable to remember all locations, he must concentrate on the most prominent.

Exposure Time

- Moving targets are only exposed for a short time.
- The sniper must be alert to note points of disappearance of as many targets as possible before engagement.
- He should take several of them under fire in succession.

Evaluating Aiming Points

- Targets which disappear behind good aiming points are easily remembered.
- Targets with poor aiming points are easily lost. When two targets of the same value, that are equally dangerous, present themselves, the sniper will engage the POOR aiming point first.

CONSIDERATIONS

TARGET DETECTION

Depending on the skill of the enemy the sniper is employed against, the difficulty in locating that enemy will range from difficult in detecting a carefully moving patrol to almost impossible detecting scouts or other snipers.

The following are indicators that lead to detection:

INDICATORS

- **MOVEMENT.** The hasty search provides the best means for picking out movement.
- **IMPROPER CAMOUFLAGE.** A majority of the targets on the battlefield will be detected because of improper camouflage. However, many times an observation post or enemy firing position will blend almost perfectly with the natural background. Only through extremely careful, detailed searching will these positions be revealed.
- **SHINE.** Shine may come from many sources, such as eye-glasses, reflective metal, optical devices, pools of water, and even the natural oils from the skin. Shine may only last for a second, so the sniper has to be alert to observe it.

INDICATORS
(Continued)

- **OUTLINE.** Most enemy soldiers will use camouflage on themselves, their equipment, and positions. The sniper must be able to identify objects, even if he can only see parts of them, and see them from unusual angles.
- **CONTRAST.** Unusual color stands out against its background (e.g., dead vegetation), as does a piece of improper camouflage, a small patch of fresh soil, and unburied communication wire. While observing, anything that looks out of place or unusual should be studied in minute detail by the sniper. Curiosity will greatly increase the chances of spotting the hidden enemy.
- **SOUND.** Sound can be used to detect an enemy position.
- **CRACK AND THUMP METHOD.** The first sound heard will be the crack of the bullet flying at supersonic speed as it passes overhead. More than one crack may be heard if the bullet passes several objects. This is always followed by a lower sounding thump. This is the discharge of the rifle. At short ranges, the sounds will be close together. As the range increases, the sounds are farther apart. With practice, one can determine the distance to the firer. A 1-second lapse between crack and thump is about 600 yards; a ½-second lapse is 300 yards. Once range has been determined, by watching in the direction of the sound, a trained observer can usually identify the enemy position.

A sniper selects targets according to their value. A target's real worth is determined by the sniper and the nature of his mission.

- Officers
- Noncommissioned officers
- Scouts
- Crew-served weapons personnel
- Tank commanders
- Communication personnel
- Snipers

A sniper's target may be forced upon him. He may lose a rapidly moving target if he waits to identify it in detail. He must consider any enemy who threatens his position as a very high-value target. When able to make a choice, there are certain factors to consider:

TARGET SELECTION

KEY TARGETS

CONSIDERATIONS OF SELECTION

- **DISTANCE.** Not risking a shot without special reason. A normal shot is between 600 and 1,000 yards; 800 yards would be a good medium. Also, a sniper should never fire at less than 300 yards because of the danger of being spotted, unless his position is being threatened.
- **MULTIPLE TARGETS.** A sniper should carefully weigh the possible consequence of shooting at one of a number of targets, especially when he cannot identify the target in detail. He may trade his life for an inconsequential target by putting himself in a position of a defensive fire fight. **ONLY** when a sniper is positively sure his position will not be exposed or detected will he fire more than **THREE** shots from any one position. A well-placed shot can disable crew-served weapons, radios, vehicles, and other equipment. However, such equipment may be used as bait for more targets coming to assume control of the equipment.

INFORMATION COLLECTION

When in position close to the enemy, the sniper must be absolutely sure of his decision to fire. He must ask himself if he observed longer, would the information he gathered far exceed the value of a kill. The well-trained sniper will sensibly evaluate such situations.

402. RANGE ESTIMATION

Estimating range is determining the distance between two points. The ability to accurately determine range is a key skill which must be developed by the sniper. It can spell the difference between a one-shot kill and a miss.

GENERAL

There are a number of methods that can be used for estimating range:

- Measuring distance from a map.
- Pacing the distance (probably feasible only in a defensive position).
- Estimating by eye.
- Range cards.
- Use of mil scale reticle or mil scale in binoculars in conjunction with mil relation formula (range estimation formula method).

RANGE ESTIMATION METHODS

ESTIMATING BY EYE

- **100-Yard Increment Method**

To use this method, the sniper must be able to visualize a distance of 100 yards (football field) on the ground. For distances up to 500 yards, he determines the number of 100-yard increments between himself and the target. At ranges beyond 500 yards, the sniper selects a point midway to the target. He then determines the number of 100-yard increments to the halfway point, then **DOUBLES** the result. The 100-yard increment method depends on how much ground is visible to the sniper. If only a small portion of the ground is visible, the 100-yard method is not accurate.

- **Appearance-of-Objects Method**

The sniper must know the sizes and details of personnel and equipment at known ranges. He can compare these characteristics to similar objects at unknown distances and thus estimate objects at unknown distances. Snipers must be thoroughly familiar with characteristic details of objects as they appear at various ranges (such as appearance of men) in various positions (prone, kneeling, or standing). The sniper establishes a series of mental images which will help him determine ranges on unfamiliar terrain. Successful use of this method depends on visibility.

- **Combination of Methods**

Under proper conditions, the 100-yard unit of measure or the appearance-of-objects methods are effective ways of determining range. However, proper conditions rarely exist on the battlefield. Terrain with a lot of deadspace limits the accuracy of the 100-yard increment method, and visibility limits the accuracy of the appearance-of-objects method. The sniper will get a more accurate estimate of range if he utilizes a combination of several methods to support his answer. If both team members come up with a different estimate of range to a target, an average between the two answers is taken.

- **Bracketing Method**

This method is used if the sniper assumes the target is no more than "X" meters away, but no less than "Y" meters. He then estimates a distance somewhere between "X" and "Y."

- **Range Card Method**

Information contained on the sniper's range cards establishes reference points from which the sniper can judge distance rapidly and accurately. When a target appears, its position and range are quickly determined.

- **Range Estimation Formula Method**

This method requires the use of either binoculars or telescopic sights, equipped with mil scales. To use the formula, the sniper must know the average height of a man or any given piece of equipment, and he must be able to express the height of the target in **YARDS** as follows:

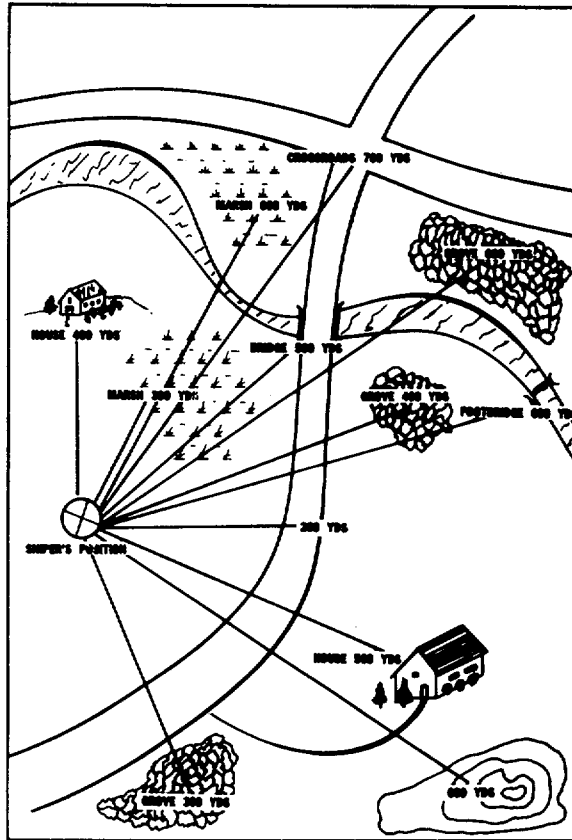

Figure 4-1. Field Expedient Range Card.

$$\frac{\text{Size of Objective (in yards)} \times 1,000}{\text{Size of Objective (in mils)}} = \text{Range}$$

EXAMPLE: A sniper, looking through his scope sees a man standing. He measures the size of the man, using the mil scale reticle in the scope or the binoculars, and determines that the man is 4 mils high. He has previously determined that the average enemy is 6 feet tall. To convert that figure to yards, he divides by 3 and finds the average enemy is 2.0 yards tall.

$$\frac{2.0 \times 1,000}{4} = \frac{2,000}{4} = 500 \text{ yards}$$

(See appendix A for the formula worked out for various average sizes of men and objects. When entering a conflict, the sniper should determine the average size of enemy soldiers as soon as possible.)

Once the formula is understood, the sniper need only estimate the actual height of any target (in mils) and he can determine the range to that target with extreme accuracy. If estimating range to a half-sized target (head to waist—36 inches or 3 feet), cut the formula in half:

$$\frac{1 \text{ yard} \times 1,000}{\text{Number mils head to waist}}$$

SCOPE

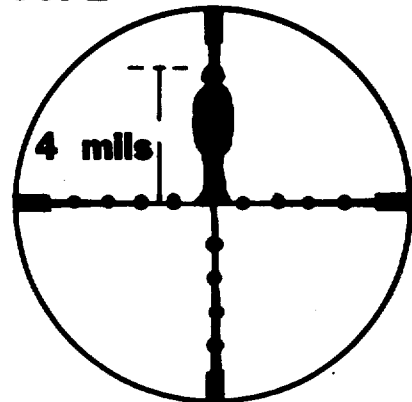

Figure 4-2. Mil Scale Reticle in Use During Range Estimation.

LIMITATIONS

While this formula can be extremely accurate, it does have limitations:

- At long ranges, measurement in mils must be precise to the nearest quarter mil or a miss can result. **EXAMPLE:** A man standing appears to be 2 mils high; he is 1,000 yards away. If he is actually 1 3/4 mils high, he is 1,143 yards away. Careless measurement could result in a range estimation error of 143 yards, therefore resulting in a miss.
- As with any formula, care must be taken, or a totally wrong answer can result. The formula depends entirely on the sniper's ability to estimate actual heights of targets in mils.

FACTORS AFFECTING RANGE ESTIMATION

FACTORS TO BE CONSIDERED IN DETERMINING RANGE BY EYE	OBJECTS APPEAR NEARER THAN THEY REALLY ARE	OBJECTS APPEAR MORE DISTANT THAN THEY REALLY ARE
THE TARGET—ITS CLEARNESS OF OUTLINE AND DETAILS	WHEN MOST OF THE TARGET IS VISIBLE AND OFFERS A CLEAR OUTLINE.	WHEN ONLY A SMALL PART OF THE TARGET MAY BE SEEN OR IS SMALL IN RELATION TO ITS SURROUNDINGS.
NATURE OF THE TERRAIN OR POSITION OF THE OBSERVER	WHEN LOOKING ACROSS A DEPRESSION MOST OF WHICH IS HIDDEN FROM VIEW.	WHEN LOOKING ACROSS A DEPRESSION ALL OF WHICH IS VISIBLE.
	WHEN LOOKING DOWNWARD FROM HIGH GROUND.	WHEN LOOKING FROM LOW GROUND TOWARD HIGH GROUND.
	WHEN LOOKING DOWN A STRAIGHT, OPEN ROAD OR ALONG A RAILROAD TRACK.	WHEN FIELD OF VISION IS NARROWLY CONFINED AS IN TWISTED STREETS, DRAWS, OR FOREST TRAILS.
LIGHT AND ATMOSPHERE	WHEN LOOKING OVER UNIFORM SURFACES LIKE WATER, SNOW, DESERT, OR GRAIN FIELDS. IN BRIGHT LINE OR WHEN THE SUN IS SHINING FROM BEHIND THE OBSERVER.	IN POOR LIGHT SUCH AS DAWN AND DUSK, IN RAIN, SNOW, OR FOG, OR WHEN THE SUN IS IN THE OBSERVER'S EYES.
	WHEN THE TARGET IS IN SHARP CONTRAST WITH THE BACKGROUND OR IS SILHOUETTED BY REASON OF SIZE, SHAPE, OR COLOR.	WHEN THE TARGET BLENDS INTO THE BACKGROUND OR TERRAIN.
	WHEN SEEN IN THE CLEAN ATMOSPHERE OF HIGH ALTITUDES.	

Figure 4-3. Range Estimation Chart.

403. CAMOUFLAGE

Camouflage, to the sniper, is the personal concealment he uses in combat to remain undetected by the enemy. Along with knowing how to adapt his dress for the best concealment, the sniper must also know how to use the ground, proper firing positions, and routes during movement to remain hidden.

TARGET INDICATORS

A TARGET INDICATOR IS ANYTHING A SNIPER DOES OR FAILS TO DO THAT WILL REVEAL HIS POSITION TO AN ENEMY.

A sniper must know these target indicators if he is to locate the enemy as well as prevent the enemy from locating him. These indicators are grouped into three general areas—sound, movement, and improper camouflage.

Sound can be made by movement, equipment rattling, or talking. The enemy may dismiss small noises as natural, but when someone speaks, he knows for certain someone is near. Silencing gear should be done before a mission, so that it makes no sound while running or walking.

SOUND

The sniper must move by slow, smooth, deliberate movements, being conscious of where he puts his feet and how he pushes aside brush to move through it.

The human eye is attracted to movement. A stationary target may be impossible to locate, a slowly moving target may go undetected, but a quick or jerky movement will be seen quickly.

MOVEMENT

A sniper must be able to move undetected while under observation of optical equipment. *Again, slow, deliberate movements are needed.*

A large number of targets will usually be detected by improper camouflage. They are divided into three groups:

IMPROPER CAMOUFLAGE

SHINE. Shine comes from reflective objects exposed and not toned down. The lenses of optical gear will reflect light. This can be stopped by putting a paper shade over the end of the optics and by staying in shadows. Any object that reflects light should be camouflaged.

OUTLINE. The outline of items such as the body, head, rifle, or other equipment must be broken up. Such outlines can be seen from great distances. Therefore, they must be broken up into features unrecognizable, or unnoticeable from the rest of the background.

When using a position for concealment, a background should be chosen that will absorb the appearance of the sniper and his gear. Contrast means standing out against the background, such as a man in a dark uniform standing on a hilltop against the sky. A different color or shape from the background will usually be spotted. Therefore, a sniper must use the coloring of his background and stay in shadows as much as possible.

TYPES OF CAMOUFLAGE

STICK CAMOUFLAGE

In using stick camouflage, all the exposed skin should be covered, to include the hands, back of the neck, ears, and face. The parts of the face that naturally form shadows should be lightened. The predominate features that shine should be darkened, such as the forehead, cheeks, nose, and chin.

The pattern and coloring that should be used is one that will blend with the natural vegetation and shadows. For jungle or woodland, dark and light green are good. White and gray should be used for snow areas, and light brown and sand coloring for deserts.

PATTERNS

The types of facial patterns can vary from irregular stripes across the face to bold splotching. The best pattern, perhaps, is a combination of both stripes and splotches. What one does not want is a wild type design and coloring that stands out from the background.

CLOTHING—GHILLIE SUIT

The ghillie suit is a camouflage uniform or outer smock that is covered with irregular patterns of garnish of blending color. Strips of garnish are folded in half and sewn mainly on the back, legs, arms, and shoulders. Then the strips are frayed or cut longways to give the suit the appearance of vegetation. The suit can also incorporate a close-mesh netting sewn to the back of the neck and shoulders, and then draped over the head to form a veil. The veil is used while in position to break up the outline of the head, hide the rifle scope, allow movement of the hands without fear of detection, and conceal the



Figure 4-4. Ghillie Suit, Front View.



Figure 4-5. Ghillie Suit, Back View.

ejection of brass. The veil, when draped over the head, should come down to the stomach or belt and have camouflaged garnish tied in it to break up the outline of the head and the solid features of the net. When the sniper is walking, he pushes the veil back on his head and neck so that he will have nothing obstructing his vision or hindering his movements. The veil is, however, worn down while crawling into position or near the enemy.

The ghillie suit does not make one invisible. A sniper must still take advantage of natural camouflage and concealment. Small loops should be sewn to the suit to hold natural vegetation, such as grasses and other vegetation that will not wilt quickly.



Figure 4-6. Sniper (Prone) in Ghillie Suit, Head Veil Up.

WHEN WEARING THE GHILLIE SUIT, THE SNIPER WOULD CONTRAST WITH REGULAR TROOPS, MAKING HIM A PRIME TARGET, SO IT SHOULD ONLY BE WORN WHEN THE SNIPER IS OPERATING ON HIS OWN.

FIELD EXPEDIENTS

If the desired components for the construction of a ghillie suit are not on hand, a makeshift suit can be made by expedient measures.



Figure 4-7. Ghillie Suit Using Canvas and Burlap With a Field Cover.

The garnish can be replaced by cloth discarded from socks, blankets, canvas sacks, or any other material that is readily available. The material is then attached to the suit in the same way. What is important is that the texture and outline of the uniform are broken up. The cloth or any other material can be varied in color by using mud, coffee grounds, charcoal, dye, or paint. Oil and grease should not be used because of their strong smell. Natural foliage helps greatly, when attached to the artificial camouflage, to blend in the suit with the background. As the foliage grows old, or the terrain changes, it must be changed on the suit. A normal field cover can be camouflaged with garnish or a garnish substitute (when netting is not available) to break up the outline of the head.

CAMOUFLAGING EQUIPMENT

One of the objects of primary concern for camouflaging is the rifle. One has to be careful in camouflaging the rifle to ensure that the operation of the rifle is not interfered with, that the sight is clear, and that that nothing touches the barrel. Camouflage netting can be attached to the stock, scope, and sling, then garnish tied in the netting to break up their distinctive outline. The stock and barrel can be painted for special terrain, such as snow and desert areas. The M16 can be camouflaged in the same way, ensuring that the rifle remains fully operational.

RIFLE

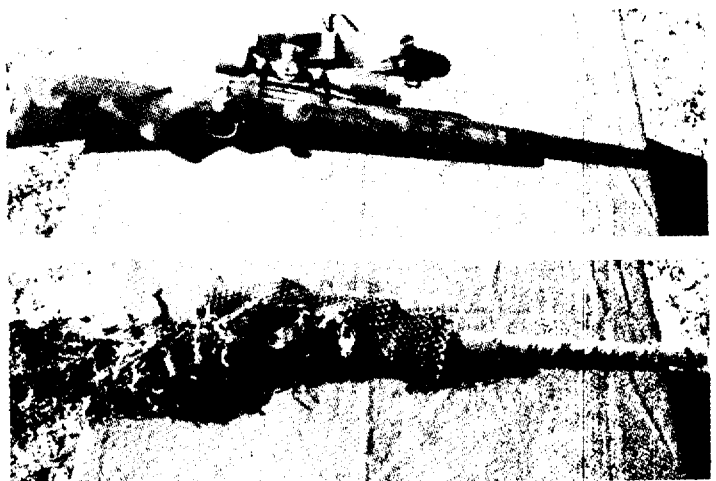

Figure 4-8. Plain Rifle vs Camouflaged Rifle.

Optical gear such as the M49 scope and binoculars are camouflaged in the same manner. The M49 and stand is wrapped or draped with netting and then garnish is tied into it, making sure that the outline is broken up and that the colors blend in with the terrain. The binoculars are wrapped with netting to break up their distinctive form. Since glass reflects light, a paper hood can be slipped over the objective lens on the scope or the binoculars.

OPTICAL EQUIPMENT



Figure 4-9. M49 and Binoculars, Camouflaged.

PACKS AND WEB GEAR

Naturally, one type of camouflage can not be used in all types of terrain and geographic areas. Before operations in an area, a sniper should study the terrain, vegetation, and lay of the land to determine the best possible type of personal camouflage.

In areas with heavy snow or in wooded areas with brush covered with snow, a full white camouflage suit, possibly with gray shading, is worn. With snow on the ground and the brush not covered, white trousers and green-brown tops are worn. A hood or veil in snow areas is very effective, and equipment should be striped or totally covered in white. In snow regions, visibility during a bright night is nearly as good as in the day, giving snipers full-time capabilities, but movement must be undertaken along carefully concealed routes. Firing positions can be made almost totally invisible if selected with care.

Web gear can be camouflaged by dying, tying garnish to it, or attaching netting with garnish. The pack can be camouflaged by laying a piece of netting over it, tied at the top and bottom. Garnish is then tied into the net to break up the outline. Natural vegetation should also be used when possible, but not in excess, because of noise, movement, and wilting.

CAMOUFLAGE IN DIFFERENT GEOGRAPHIC AREAS

SNOW

DESERT

In sandy and desert areas, texture camouflage is normally not so necessary. Still, proper coloring of a suit that breaks up the sniper's human outline is needed. A bulky type smock of light material with a hood works well. The hands, face, and all equipment should be blended into a solid pattern after the terrain. The sniper must make full use of the terrain by properly selected and concealed routes of movement. For the most part, movement would be done under the cover of darkness with the sniper team hidden or set in position by daylight (for protection from elements).

URBAN AREAS

When deployed with regular troops in a built-up area, the sniper should be dressed as the troops are. But when the sniper is in position, he should be camouflaged to match the area he is in. A bulky, shapeless camouflage suit can be used that has been colored to match rubble and debris of the urban area, making sure the outline of the head is broken up by some type of hood. Movement should be extremely slow and careful, if at all, during daylight hours because of the unlimited amount of possible enemy sniper positions. Movement under the cover of darkness is preferable, being set in position by first light.

JUNGLE

In jungle areas, foliage, artificial camouflage, and camouflage paint are used in a contrasting pattern that will blend with the texture of the terrain. In a very hot and humid area, only a light camouflaged suit can be worn because of the great loss of body fluids caused by wearing a heavy suit. The vegetation is usually very thick, so more dependence can be made on using the natural foliage for concealment.

THE SNIPER MUST BE CAMOUFLAGE CONSCIOUS FROM THE TIME HE DEPARTS ON A MISSION UNTIL THE TIME HE RETURNS.

CAMOUFLAGE DURING MOVEMENT

The sniper must constantly observe the terrain and vegetation changes to pick the most concealed routes of advance and to be certain he is camouflaged properly. He should utilize shadows caused by vegetation, terrain features, and cultural features to remain undetected. He must master the techniques of hiding, blending, and deceiving.

HIDING

Hiding is completely concealing the body from observation by laying in very thick vegetation, under leaves, or even by digging a shallow trench and covering up in it. The technique of hiding may be used if the sniper stumbles upon an enemy patrol and immediate concealment is needed, or if the sniper wishes to "lay low" during daylight hours to await darkness.



Figure 4-10. Sniper Blending With Terrain.

Blending is the technique used to the greatest extent in camouflage, since it is not always possible to completely camouflage in such a way as to be indistinguishable from the surrounding area. A sniper must remember that his camouflage needs to be so nearly perfect that he can not be recognized through optical gear nor with the human eye. He must be able to be looked at directly and not be seen. This takes much practice and experience.

BLENDING

In deceiving, the enemy is tricked into a false conclusion regarding the sniper's location, intentions, or movement. By planting objects such as ammunition cans, food cartons, or something to intrigue, the sniper decoys the enemy into the open where he can be brought under fire. Cutting enemy communication wire and waiting for the repair personnel is another technique. After a unit has left a bivouac area, a sniper can be left behind to watch for enemy scouts that may search the area. Mannequins can be used to lure the enemy sniper into firing, thereby revealing his position.

DECEIVING

Probably at no other time during the course of the mission will the sniper have more of a tendency to be careless than when he is returning to a friendly area. Fatigue and undue haste may override caution and planning. The enemy will have more intensive intelligence as the sniper's activities become known. Camouflage, concealment, and cautious movement then become of paramount importance. Attention to every detail and careful planning will enable the sniper to return safely to his unit and be available to execute another mission.

RETURN TO FRIENDLY AREA

404. INDIVIDUAL MOVEMENT

Before a mission, there are a few items of preparation with which a sniper needs to pay particular attention. One is to plan a primary and an alternate route to and from the objective. This is done by studying, in depth, large-scale maps and aerial photographs of the area, and talking to people who have been through the areas before. He must know as much as possible about an area before moving through it. He must allow enough time for proper camouflage, which should match the type of terrain he will be moving through.

Prior to movement, an inspection should be held for all personnel to ensure that all shiny equipment is toned down, and that all gear is silenced. The sniper must ensure that only mission essential gear is taken along.

PREPARATION FOR MOVEMENT

ROUTE SELECTION

In selecting routes of movement, a sniper should try to avoid known enemy positions and obstacles. Open areas and exposed ridges should be avoided. He should seek routes with cover and concealment; trails should never be used. Advantage should be taken of the more difficult terrain—swamps, dense woods, etc. Areas believed to be under enemy observation, mined, or boobytrapped should be avoided. Villages or areas where the snipers are likely to meet natives should be skirted.

MOVEMENT

Normal infantry movement will not totally apply to a sniper. Snipers moving in small teams in the proximity of enemy troops cannot afford to be seen at anytime. Therefore, the sniper has to be doubly careful which, in turn, means he has to move considerably slower.

There are two important rules to remember about movement:

- Always assume the area is under observation.
- During movement, stop, look, and listen; plan the route; then move by bounds.

The sniper always **OBSERVES** from a covered position, as low to the ground as possible. He blends into the background, such as grass or brush, before observing. He looks around objects or through brush, not over it, noting everything in detail, and using binoculars if needed.

The sniper **LISTENS** to every sound. His senses must be fully alert.

The sniper **PLANS THE ROUTE** to the next observation point. He moves under the most concealed routes by using necessary methods of walking or crawling. Upon reaching the next point, he repeats the process. The type of terrain will dictate the speed of travel. It may mean moving slowly, but if he is spotted, his life and mission are compromised.

TYPES OF MOVEMENT

SLOW AND DELIBERATE

WALK

Wherever the sniper is walking, he walks carefully, distinctly, and quietly. He is conscious of every step he takes, whether moving with troops or on his own. He **STOPS, LOOKS, and LISTENS** periodically. He walks in a crouch to maintain a low profile with shadows and bushes so as not to be silhouetted. Most of the enemy will be looking for an upright man.

He very slowly lifts one foot and moves it forward, clearing obstacles, with the toes straight to the front. He picks out a point one-half a normal stride to the front, preferably free of dry leaves and twigs, then places the toes or outside edge of the foot down lightly to get the feel of the ground. He rotates the foot down onto the ball of the foot. He continues placing the foot until the heel is down with no weight on the foot. Now, very slowly, he starts to shift the body weight forward until it all rests on the forward foot, but slowly enough that it makes no sound. He repeats the process with the opposite foot. The terrain will determine the speed and silence of movement.



Figure 4-11. Sniper Moving Upright (Walking).

LOW CRAWL



Figure 4-12. Sniper in Low Crawl.

To carry the rifle, the sniper grasps the upper portion of the sling, laying the stock on the back of the hand or wrist with the rifle laying on the INSIDE of the body. The rifle can also be put along the side of the body, under one arm, to be pushed forward as the sniper moves. The rifle should be protected from abuse. The sniper must be sure that the muzzle does not protrude into the air or stick in the dirt.

To move forward, the sniper extends his arms to the front and digs his toes into the ground. Then very slowly, he pulls with his arms and pushes with the feet. He is careful not to raise his head or heels of his feet into the air.

It takes a lot of practice to be able to move as slowly and smoothly as necessary, not allowing quick or jerky movements. All movement must be very slow and deliberate, with all parts of the body kept as low to the ground as possible (especially the head).

The low crawl is used when cover and concealment are low or scarce, when the enemy is near or has a clear field of view to the sniper's position, or when moving into a final firing position. It is slow, so speed cannot be essential.

To "low crawl," the sniper lays his body as flat on the ground as possible, legs together, feet flat on the ground or pointed to the rear, and arms to the front and flat on the ground.

To keep from snagging and moving the vegetation (thereby causing detectable overhead movement), nothing, including the rifle, elbows, or feet should extend beyond the edge of his body.



Figure 4-13. Rifle Position When Crawling.

MEDIUM CRAWL

The medium crawl is similar to the low crawl in that it is used in fairly low cover. It is faster for the sniper and less tiring to the body.

All parts of the body are kept as low to the ground as possible. Instead of just pushing with the feet, one leg is cocked forward to push with. When the pushing leg is tired, the opposite leg can take over, but only one leg is used at a time for a sequence of pushing. This is to keep the lower portion of the body from raising into the air.



Figure 4-14. Medium Crawl.

HIGH CRAWL



Figure 4-15. High Crawl.

The high crawl is used when cover is more prevalent or when more speed is required.

The body is kept free of the ground and the weight rests on the arms and legs. The rifle is either carried as in the low crawl or cradled in the arms.

Movement is made by alternately pulling with each arm and pushing with one leg, if one still wishes to remain fairly low, or alternating legs for pushing if there is adequate cover.

The sniper should ALWAYS be conscious of not allowing the head and buttocks to raise too high and keeping the legs from making excessive noise when being dragged over brush and debris.



Figures 16, 17, and 18. Sequence for Turning While Crawling.

TURNING WHILE CRAWLING

It may be necessary to change direction or turn completely while crawling.

To execute a right turn, when extreme care is needed, the body is eased as far to the right as possible, keeping the legs together. The left leg is then moved as far to the left as possible and the right leg then closed to it. This will effect a turn to the right and should be repeated until the sniper is facing the required direction. All this is done very slowly, with the body as low to the ground as possible.

MOVING BACKWARDS

When cover is adequate, or silence is necessary, crawling on hands and knees can be used.

The rifle is held in one hand close to the chest and in line with the body. *The rifle is not put on the ground.* The sling is grasped by the stock to keep it from being tangled on the ground. The weight of the upper body is supported by the opposite arm.

Supporting the rifle in the left hand, the sniper picks a point ahead to position the right hand and moves it slowly into position, making no noise. While moving the right arm, the weight of the upper body can be supported by leaning on the left elbow. Once the right arm is placed, the left arm and rifle is moved forward.

A point is then picked to which the knees are moved. Each leg, in turn, is lifted to clear any obstruction and softly placed into its new position. Again, the situation, ground cover, and terrain will determine the speed and silence of movement.

If absolute silence is needed, leaves, twigs, and pebbles can be removed before placing the hands and knees. The movement must be very slow and soft, with breathing being very shallow through the mouth.

NIGHT MOVEMENT

NIGHT VISION

Sometimes it may be necessary to withdraw from a position. This can be done by the low crawl in reverse, pushing instead of pulling with the arms.

HANDS AND KNEES CRAWL

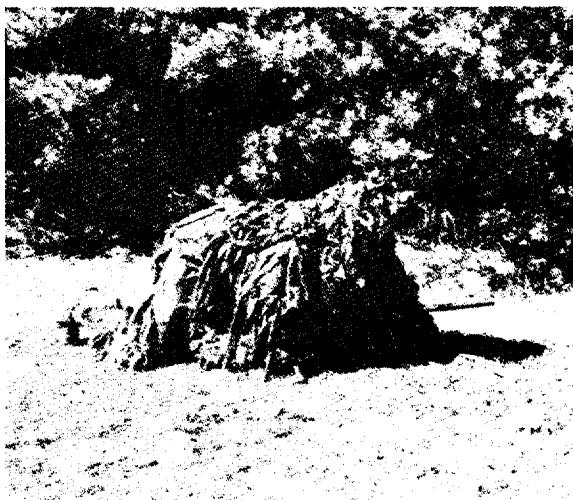

Figure 4-19. Hands and Knees Crawl.

Night movement is essentially the same as in the day, except that it must be slower and more deliberate because of the limited visibility. One has to rely on the senses of touch and hearing to a greater extent.

If at all possible, a sniper should move under the cover of darkness, fog, haze, rain, or high winds to conceal his movements. This is a safety factor; but the enemy is harder to spot and specific positions or landmarks are harder to locate.

Before moving at night, the sniper lets his eyes adjust to the darkness for at least 30 minutes. To distinguish an object in the dark, he should look 5 to 10 degrees away from the object, getting low to the ground in order to silhouette the object against the sky. If one looks directly at an object in the dark, it will distort, or when the eyes are tired, it will completely disappear.

Concealment is not as critical at night, but staying next to a dark background and not being silhouetted is. Quick movement at night is easily seen, and sound travels farther and clearer. In the darkness, slow and silent movement is essential.

While moving, the sniper listens to the night noises for anything out of place or unusual, and he continually scans for movement. Also, he takes advantage of wind and other noises to mask movements.

At night, the senses have to be relied upon to a great extent. He learns to trust them and be able to interpret what they are telling him. The enemy may even be located by the sense of smell, such as food, vehicles, or garbage.

ALL OF A SNIPER'S GEAR SHOULD BE ARRANGED SO THAT IT MAY BE GOTTEN TO QUICKLY IN THE DARK, ALWAYS KEEPING IT WITHIN HAND'S REACH WHILE IN POSITION.

Stalking is the sniper art of moving unseen into a firing position within a range that will ensure a first-round kill and then withdrawing undetected. The stalk incorporates all aspects of fieldcraft and can only be effectively learned by repeated practice over various types of ground.

STALKING

RECONNAISSANCE

Any stalk through open terrain or otherwise undertaken without first doing a thorough reconnaissance (map or physical) is likely to have limited success. Opportunities to view the ground may be rare in an actual situation; therefore, the sniper must be an expert with the map and aerial photograph so that maximum information can be gleaned from both.

BEFORE STALKING

The exact location of the enemy position to be stalked should be noted and memorized. Particular attention should be given to nearby features and landmarks that are to be remembered (to aid in terrain countdown).

An area which appears to present the best possible firing position is selected, though the exact firing position can rarely be pinpointed in advance. The best line of advance is selected and the route is split into bounds; as each bound is reached, the next can be considered in greater detail.

REMEMBER. Once a sniper is committed to a line of advance, he may find great difficulty in changing it, so great skill is needed in the initial terrain and route analysis.

Particular points to consider are:

- The availability of natural cover and, in particular, any dead space.
- The position and frequency of any obstacles, whether natural or artificial.
- Likely points along the line of advance from which observations can be made. When possible, these should coincide with the finish and start of the planned bounds.
- The location of known or possible enemy locations.
- The general method of movement likely for each bound (crawling, walking, etc.), after an analysis of the concealment offered and the distance from the enemy considered. This is important, since it will be this in relation to the distance to be stalked that will dictate the length of time required.
- The withdrawal route should differ from that of the approach if at all possible and should be planned in a similar manner. It is important that patience is maintained during a withdrawal, since the enemy will be much more alert at this stage than during the approach. After the shot, the sniper stays motionless, in position, as long as possible.

WHILE STALKING

It is easy to lose the sense of direction while stalking, particularly if the sniper has to crawl for any appreciable distance. The chances of this happening can be reduced if:

- The use of a compass, map, and aerial photograph have been mastered (route, direction, and distance to various checkpoints planned thoroughly and accurately).
- A distinct landmark or two, or even a series, have been memorized (terrain countdown and a limiting feature).
- The direction of the wind and sun are noted; bear in mind that, over a long period of time, the wind direction can change, and the sun will change position.
- The sniper has the ability to terrain associate.

The sniper must be alert at all times. Any relaxation on a stalk can lead to carelessness, resulting in an unsuccessful mission, and death.

Observation must be undertaken with care and at frequent intervals. It is particularly important at the beginning and end of each bound.

If surprised or exposed during a stalk, instinctive immediate reaction is necessary. The sniper must decide whether to freeze and remain immobile or to move quickly to the nearest cover away from the point of exposure and hide.

The sniper must remember that disturbed animals or birds can draw attention to the area of approach. Advantage is taken of any local disturbances or distractions that may enable quicker movement than would otherwise be possible. It should be emphasized that such movement involves a degree of risk, and when the enemy is close, risks should be avoided.

The sniper should keep in mind any changes in local cover, since such changes will usually require an alteration to personal camouflage.

Often it will be necessary for the sniper to stalk at night in order to occupy an observation post or a firing position under the cover of darkness. The problems are much the same as stalking in daylight, except that a man is less adapted for movement at night. When at all possible, the sniper should stalk at night to be in position by first light.

NIGHT STALKING

Principle differences are:

There is a degree of protection offered by the darkness against aimed enemy fire.

While observation is still important, much more use is made of hearing, making silence vital.

Cover is less important than background, particularly, crests and skylines should be avoided.

Maintaining direction is much more difficult to achieve and places greater emphasis on a thorough reconnaissance. A compass or a knowledge of the stars may be of assistance.

The starlight scope is extremely useful when stalking at night, and it can be used as an observation aid when off the weapon. It can be used to pick routes of advance and to select proper firing positions.

ENEMY DETECTION DEVICES

With these devices, a sniper may not know that he is under observation, so the same principles of day movement would apply to the night, considering that his route of advance is always under observation.

When there is a possibility of night viewing devices being used, the sniper can combat them by very slow movement that is low to the ground, with his dark silhouette broken up by vegetation. Preferably, the sniper would move in dark shadows or treelines that would obscure the enemy's vision. Moving in defilade, through ground haze, fog, or rain, would greatly benefit the sniper by helping him to remain undetected. Use of the new infrared reflecting material, used in equipment netting, as a base for the ghillie suit will limit the enemy's infrared viewing capabilities.

Seismic intrusion detectors are monitoring devices with geophones planted in the ground along likely routes of advance to give early warning of troops or vehicle movement. These devices are triggered by vibration of the ground caused by walking or other movement. The sniper can move past the devices undetected only by the slowest and most careful movement without mistakes. The sniper, most likely, will not know the position of the devices.

The sniper can help combat the effect of seismic devices by moving with action that would activate the devices such as artillery, low-flying aircraft, rain, snow, or even a heavy wind.

Ground surveillance radars can detect troop or vehicle movement at an extended range, but only in line of sight and only if the object is moving. It takes a well-trained individual to properly monitor the device. Even then, it is not infallible.

Snipers can combat the use of ground surveillance radars by first moving in defilade, or out of the direct line of sight of the equipment. Movement should be extremely slow and low to the ground, using natural objects and vegetation to mask the movement.

It must be remembered that the enemy may be using various types of detection devices. The sniper should be aware of the type of detection device utilized by the enemy and its capabilities. This will enhance the sniper's chance of success.

STARLIGHT SCOPE AND INFRARED SCOPE

SEISMIC INTRUSION DETECTORS

GROUND SURVEILLANCE RADARS

INFRARED
HEAT
DETECTORS

Sensors that locate body heat may be used to detect the sniper. Even a motionless and camouflaged sniper would be located. One possible way to confuse such a detector would be to attach a space blanket (Mylar) to the inside of the camouflaged suit. This would reflect the body heat inward and possibly keep the sniper from being distinguished from the heat pattern of the surrounding terrain. This would work best when the temperature is warm and the greatest amount of radiant heat is rising from the ground.

Once a sniper has learned camouflage and movement to perfection, he must go one step further. He must develop the skill of leaving no trace of his presence, activities, or passage in or through an area.

TRACKS AND SIGNS

ENEMY TRACKERS AND SCOUTS

The greatest danger to a sniper is not the regular enemy soldier but, in fact, the hidden boobytrap, the enemy scout, or the enemy sniper who can hunt the sniper on his own terms.

There are many people in third world countries that make their livelihood by hunting for food and who are very adept at tracking. What a real tracker can determine from a trail is phenomenal.



Figure 4-20. Enemy Scout Tracking a Sniper.



Figure 4-21. Hiding a Trail.

Depending on the weather and terrain, a tracker will be able to determine the exact age of the trail, the number of persons in the party, whether or not they are carrying heavy loads, how well trained they are (determined by how well they moved), their nationality (indicated by their habits and prints left by boot soles), how fast they are moving, and approximately where they are at the moment. Sometimes, the type of movement indicated by a trail will give an indication whether or not the group is in the actual conduct of a mission or returning from one. If scouts determine a trail to be that of a sniper or reconnaissance team, the enemy will go to almost any extreme to capture or kill them.

In combat, the chances of being pitted against a real tracker are rare, but the importance of leaving NO sign at all for the enemy scout to read cannot be overemphasized. This is done by paying particular attention to where and how the movement is conducted, not walking in loose dirt or mud (if it can be avoided), and not scuffing the feet. Walking on leaves, grass, rocks, etc., can help hide tracks. Trails can be made by broken vegetation (e.g., weeds, limbs), scrape marks on bushes, and limbs that have been bent in a certain direction. When moving through thick brush, the sniper gently moves the brush forward, slips through it, and then puts it back to its normal position. Mud or dirt particles left on rocks or exposed tree roots are a sign of one's presence. Even broken spider webs up to the level of a man's height indicate there has been movement through the area.

In the process of hiding his trail, a sniper must remember to leave no debris such as paper, C-ration cans, spilled food, etc., behind him. Empty ration cans can either be carried out or

THERE IS LITTLE OR NO WAY TO HIDE A TRAIL FROM A PROFESSIONAL TRACKER.

smashed, buried, and camouflaged. The smell of urine on grass and bushes lasts for many days in a hot, humid environment; therefore, a hole should be dug for urination. A hole for excrement should also be dug and camouflaged. Other objects of importance are the fired casings from the sniper rifle which must ALWAYS be brought back, for they are a sure sign of a sniper's presence.



Figure 4-22. Fired Casings Left Behind by Sniper.

READING TRACKS AND SIGNS

To be proficient at tracking takes many years of experience, but a knowledgeable sniper can gain much information from signs left by the enemy. For instance, he can estimate the amount of enemy movement through a given area, the size units they move in, and which areas they frequent the most. If an area is found where the enemy stopped, it may be possible to determine the size of the unit and how well disciplined they are by the security that was kept. It can be fairly certain that the enemy is well fed if pieces of discarded food or ration cans containing uneaten food are found. The opposite will be true for an enemy with little food. Imprints in the dirt or grass can reveal the presence of crew-served weapons, such as machineguns or mortars. Ammunition cans, water-cans, radio gear, or other supplies may also leave prints. The enemy's habits may come to light by studying tracks in order that the enemy may be engaged at a specific time and place of the sniper's choosing.

A WELL TRAINED MARINE SNIPER SHOULD BE ABLE TO BE INSERTED INTO ANY TYPE OF TERRAIN, MAKE HIS KILL UNDER ADVERSE CONDITIONS, AND LEAVE NO INDICATION THAT HE WAS THERE.

405. OCCUPATION AND SELECTION OF POSITIONS

Once the sniper has received his mission, issued his warning order, and made his detailed plan, he must consider possible routes and how he is going to follow these routes to and from the objective. He also must consider locations for hasty positions or "fast find" positions, such as he might have to use in danger areas if an enemy patrol was to intersect the patrol route.

Position selection and what type of position the sniper will prepare will be governed by the type of operation the supported unit is in (e.g., combat in a built-up area). Position safety is also a prime concern to the sniper and must be maintained at all times while in position.



Figure 4-23. Selecting a Firing Position.

SELECTING ROUTES

On some sniper missions, a specific route may have to be followed by the sniper team; on other missions, the sniper may select his own routes to and from the objective area. Listed below are principles to aid the sniper in selecting his routes:

- Avoid known enemy positions and obstacles.
- Seek terrain (avoiding open areas) that offers the most cover and concealment for daylight movement.
- Seek terrain permitting movement at night.
- Take advantage of the more difficult terrain such as swamps or dense woods.
- Avoid moving along exposed ridges; move along the slope below the ridge to prevent silhouetting.

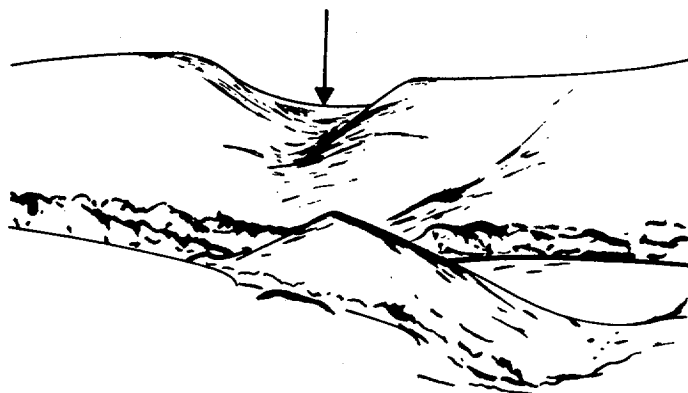

Figure 4-24. Move Along Slope Below the Ridge.

- Avoid using trails in guerrilla-infested areas and in areas between forces in contact in conventional operations.
- Avoid areas which may be mined, boobytrapped, or covered by fire or troops.
- Avoid villages, trails leading into villages, wells, and places where you are likely to meet natives of the area.

The sniper studies maps, aerial photographs, or sketches and memorizes his route before moving out. He notes distinctive features (hills, streams, swamps, etc.) and their location on his route to aid in terrain countdown. He plans alternate routes to use in case he cannot use his primary routes.

FOLLOWING ROUTES

Keeping continually oriented while moving along, the sniper observes the terrain carefully and mentally checks off the distinctive features noted in studying and planning the route. Many aids are available to help check and doublecheck the route, such as:

- The location and direction of flow of principle streams.
- Hills, valleys, and peculiar terrain features (e.g., swamps and barren areas).
- Towns, railroad tracks, powerlines, roads, and other manmade objects.
- The fire of machineguns, mortars, or artillery (mortar and artillery rounds fired on known locations can guide and help orient). These fires can be fired at designated times (scheduled fires) or fired when requested.

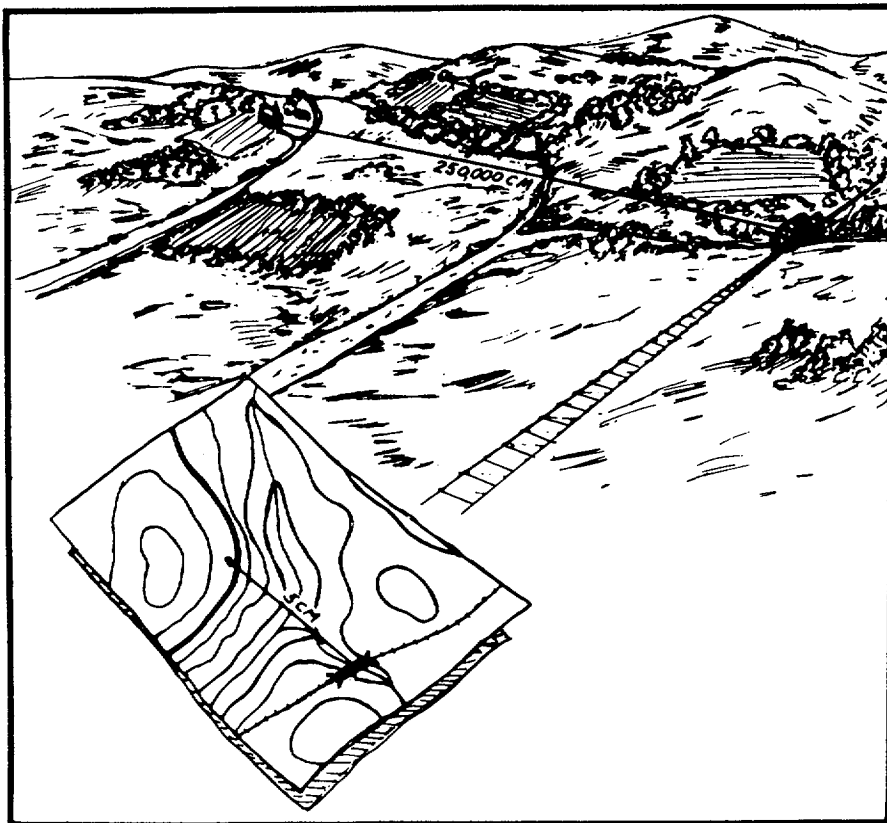

Figure 4-25. Terrain Association.

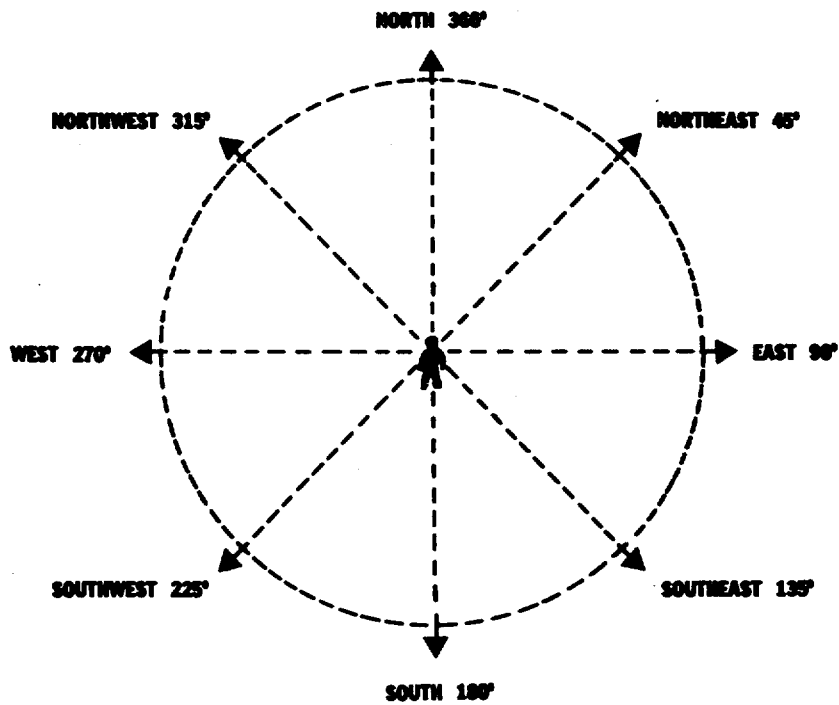

Figure 4-26. Direction Diagram.

Routes, or directions, may also be followed by the use of the sun, or the North Star. Once the sniper has found north, and is facing north (360 degrees):

- Northeast (45 degrees) is to his right foot.
- East (90 degrees) is to his right.
- Southeast (135 degrees) is to his right rear.
- South (180 degrees) is to his rear.
- Southwest (225 degrees) is to his left rear.
- West (270 degrees) is to his left.
- Northwest (315 degrees) is to his left front.

HASTY POSITIONS

A hasty position (fast find) provides protection from enemy fire or observation. It may be natural or artificial. Natural cover (ravines, hollows, reverse slopes, etc.) and artificial cover (foxholes, trenches, walls, etc.) protect the sniper from flat trajectory fires and enemy observation. Snipers must form the habit of looking for, and taking advantage of, every bit of cover and concealment the terrain offers. Combine this habit with proper use of movement techniques to provide excellent protection from enemy fire and observation.

CONCEALMENT IN HASTY POSITIONS



Figure 4-27. Sniper Team in Position.

Concealment and cover in hasty positions provides protection from enemy observation and/or fire. It may be artificial or natural. *CONCEALMENT MAY NOT BE PROTECTION FROM ENEMY FIRE.* A sniper should not make the mistake of believing he is protected from enemy fire merely because he is concealed from enemy eyes.

Natural positions are provided by the surroundings; e.g., bushes, grass, and shadows.



Figure 4-28. Sniper Using Available Cover.

Artificial type positions are positions that are manmade; e.g., shell holes, brick walls, tunnels, and buildings.

In selecting a hasty position, advantage is taken of available cover and concealment (natural or artificial).

The sniper observes and fires around the side of an object, never over it. This conceals most of the head and body. He stays low to observe and fire whenever possible.

OBSERVATION TECHNIQUES

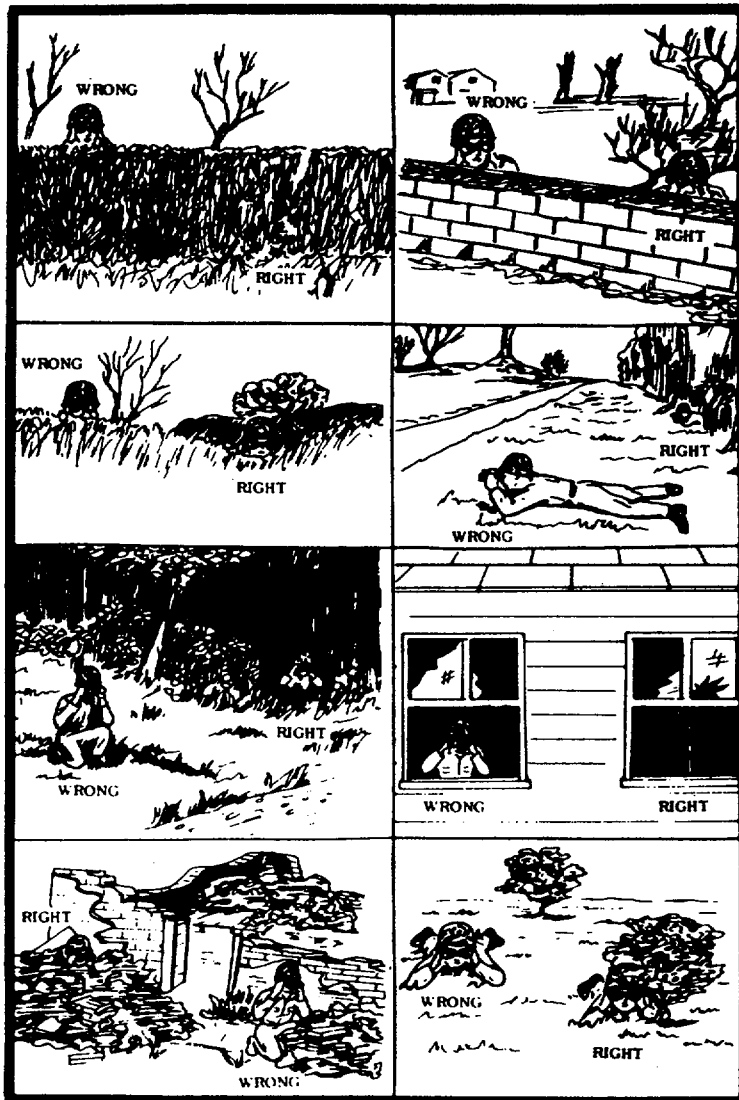

Figure 4-29. Observation Techniques.

POSITION SELECTION

The sniper, having decided upon an area of operation, must choose a specific spot from which to operate. A POSITION THAT LOOKS OBVIOUS AND IDEAL FOR A SNIPER WILL APPEAR AS SUCH TO THE ENEMY. A sniper should avoid obvious positions and stay away from prominent, readily identifiable objects. The position a sniper looks for represents an optimum balance between two considerations—it provides maximum fields of observation and fire, and it provides maximum concealment from enemy observation.

TECHNIQUES IN CONSTRUCTING AND CONCEALING SNIPER POSITIONS (HIDES)

The position should be sited to provide the best fields of fire and observation (and natural drainage, if possible). Advantage should be taken of available natural camouflage to reduce construction effort.

SITING

The first step in a good plan for constructing a position is a consideration of tools. What tools are required and what are available?

CONSTRUCTION

- | | |
|------------------|---------------------|
| Entrenching tool | * Axes |
| Bayonet knife | * Picks |
| * Shovels | * Saws and sandbags |

*Such bulky tools would probably not be carried by the sniper but provided by the backup patrol that can be used to help construct the sniper position.



Figure 4-30. Concealing Dirt.

CONCEALMENT OF FRESH SOIL

The plan for the position must include ways to dispose of the soil.

First, the sniper slices off and sets aside the topsoil and grass, digging down about 4 to 6 inches. He then starts to dig the "pit." If necessary, the sniper has a position from which to fight, if seen by the enemy. THE PIT IS ALWAYS DUG FIRST.

Drainage can be provided by sloping the bottom of the hole so that water flows to a place where it can be removed. In a two-man position, the sniper can build a "sump," a small hole at the bottom of the position, about 2 feet long, 18 inches wide, and 1 foot deep. The bottom of the sump is sloped at approximately 45 degrees.

Drainage is easy in sandy soil, but not in clay. When it rains, creek banks and low level grounds will flood. These areas should be avoided, if possible.

DRAINAGE

Sandy soil is apt to cave in at any time, and almost any soil will cave in when wet. To prevent this, the sniper can cut and weave saplings. This weaving requires a lot of saplings, all about the same size, and something with which to hammer them into the ground. Shell boxes, sandbags, scrap metal, chicken wire, corrugated metal, and scrap lumber can also be used for reinforcing the side walls.

REINFORCING

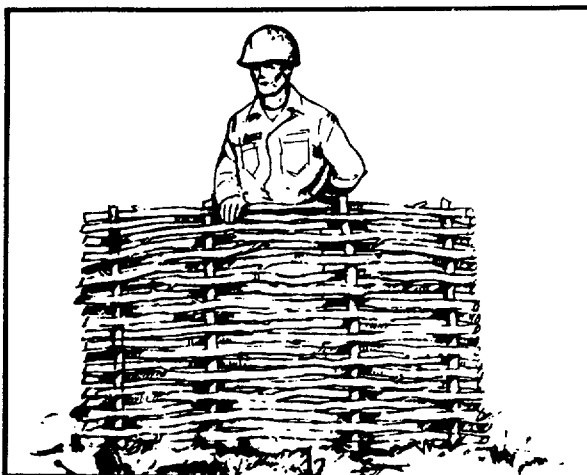

Figure 4-31. Reinforcing Sniper Position.

LOOPHOLES

The construction of loopholes requires care and practice to ensure that they afford adequate view of the required field of fire. They should be constructed so that they are wide at the back and narrow in the front, but not so narrow that observation is restricted. Loopholes may be made of old coffee tins, old boots, or any other rubbish, provided that it is natural to the surrounding or that it can be properly and cleverly concealed.

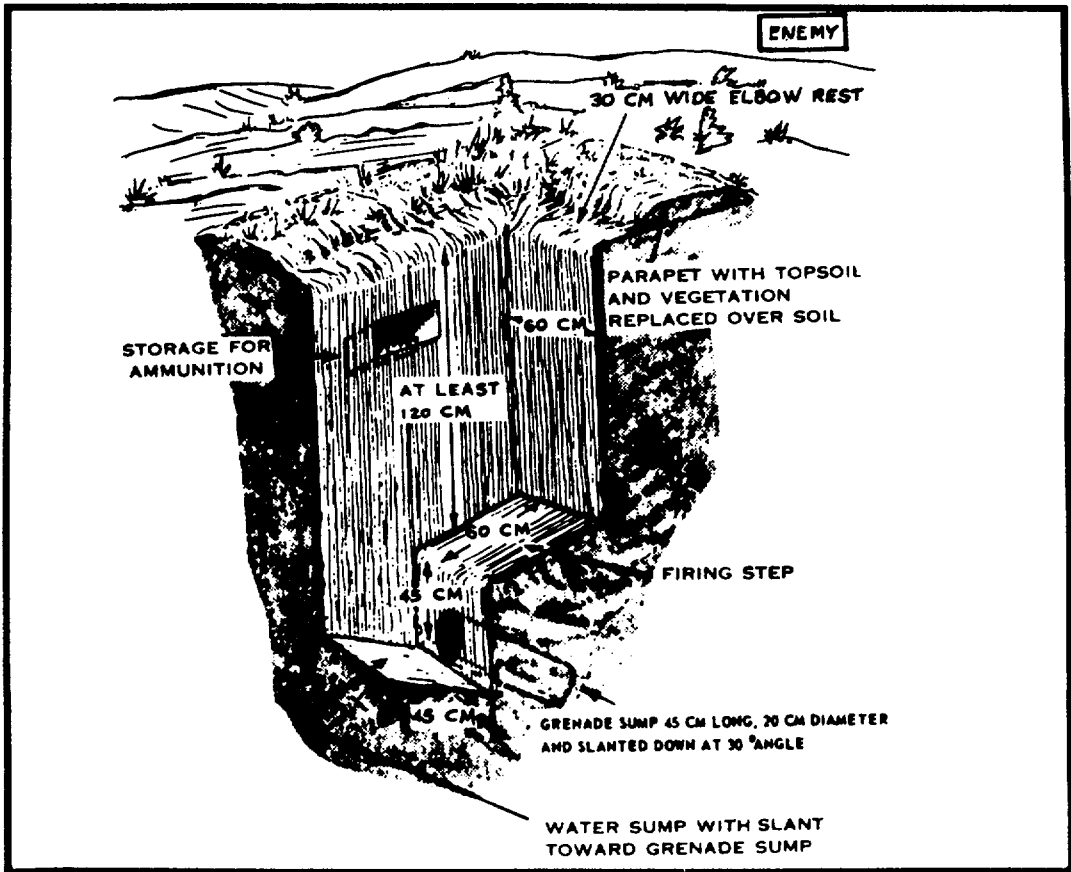

Figure 4-32. Elbow Rest.

ELBOW REST

Some form of rest for the firer and observer will have to be constructed. Such a rest can be constructed with sandbags to the rear of the firing and observation loopholes.

COVER

Covering the sniper position gives the sniper team cover, concealment, protection, and some comfort. To get this protection and comfort, the sniper team must construct the cover of the position with at least 18 inches of soil and, if time permits, logs, soil, rocks, and the sod, IN THAT ORDER. If waterproofing is desired, place it between the sod and rock layers and between the rock and soil layers (ponchos can be used). Place paper, canvas, or empty sandbags, if available, between the log and soil layers to prevent water from seeping through.

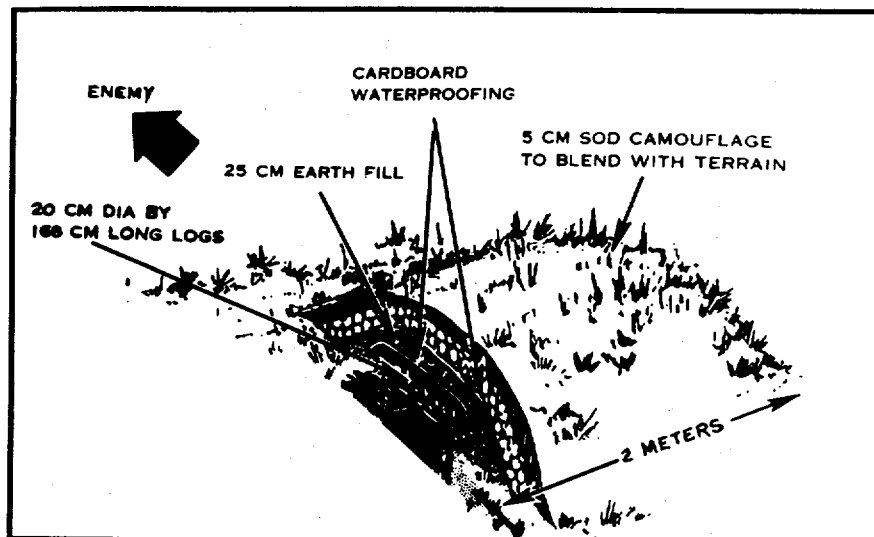

Figure 4-33. "Covered" Hide.

It is essential that the natural appearance of the ground in front and rear of the position or hide remains unaltered and that any camouflage done is of the highest order. Movement in front of the position must be held to a minimum.

FRONT AND REAR APPEARANCE

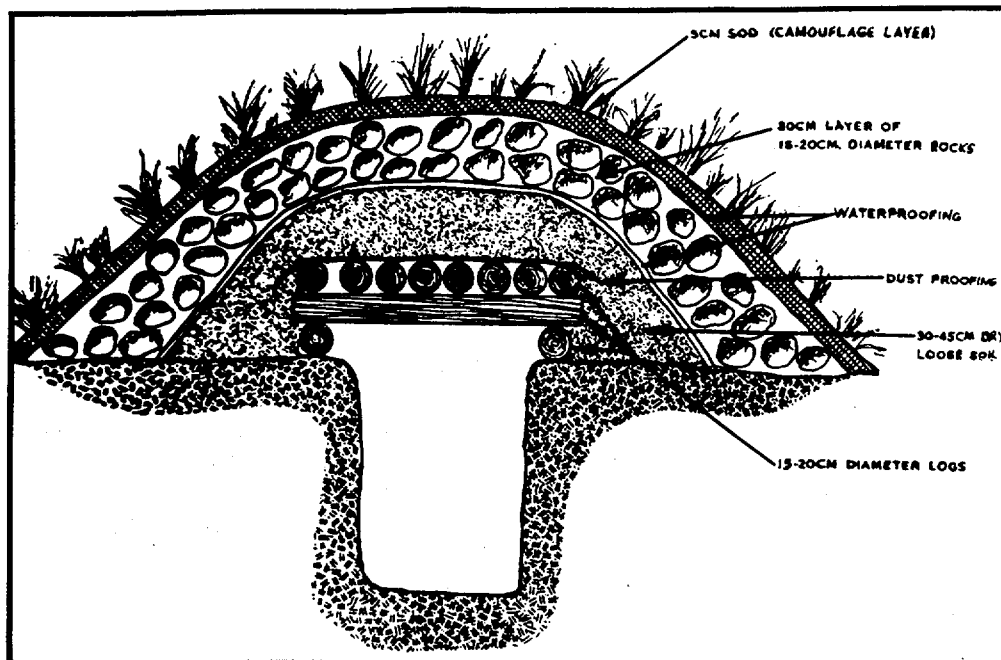

Figure 4-34. Overhead Cover.

REAR EXIT HOLE

The sniper team must have a way in and out of the position. This hole should be only big enough for the snipers to enter and leave. Once inside the position, they must cover this hole from light. Light coming from the rear will cast a light through the loopholes. A canvas curtain is used to cover the hole. This rear entrance must be well camouflaged, and movement in and out of the hide must be held to a minimum. The most vulnerable part of the sniper is his rear; therefore, claymore mines should be taken along on the sniper mission and emplaced to the rear of the hide.

If the hide is properly constructed and concealed, the enemy should be able to pass right over the top of it without suspecting the presence of snipers. In light of a possible requirement for this, all time and effort should be utilized to ensure a perfect hide. Life itself depends upon it.

OTHER TYPES OF POSITIONS (HIDES)

BELLY HIDES

This type hide is best used in mobile situations or when the sniper does not plan to be in position for any extended period of time. An advantage is that it can be quickly built; it is good when the sniper is not going to stay in position long. Disadvantages are:

- It is uncomfortable and can not be occupied for long periods of time.
- The sniper is exposed while firing.
- There is no protection from weather or fire.
- The sniper has to enter the position from the front.

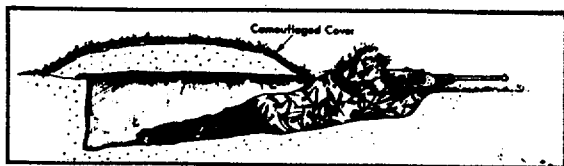

Figure 4-35. Belly Hide (Side View).

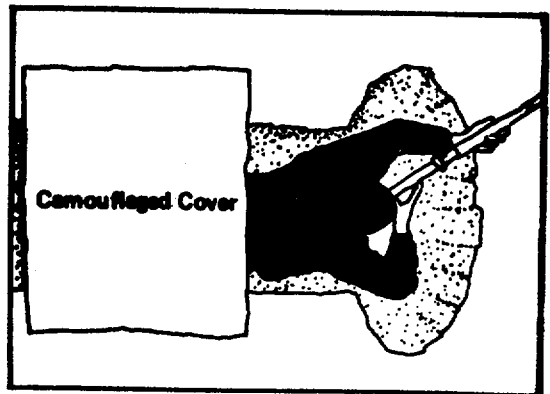

Figure 4-36. Belly Hide (Top View).

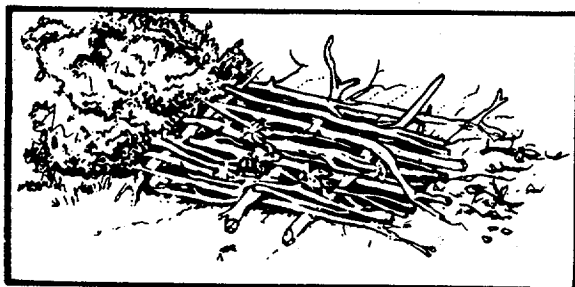

Figure 4-37. Camouflaged Belly Hide.



Figure 4-38. Camouflaged Belly Hide.

Shell holes save a lot of digging, but they need plenty of wood and rope to secure the sides. Drainage is the main disadvantage of occupying a shell hole.

SHELL HOLES

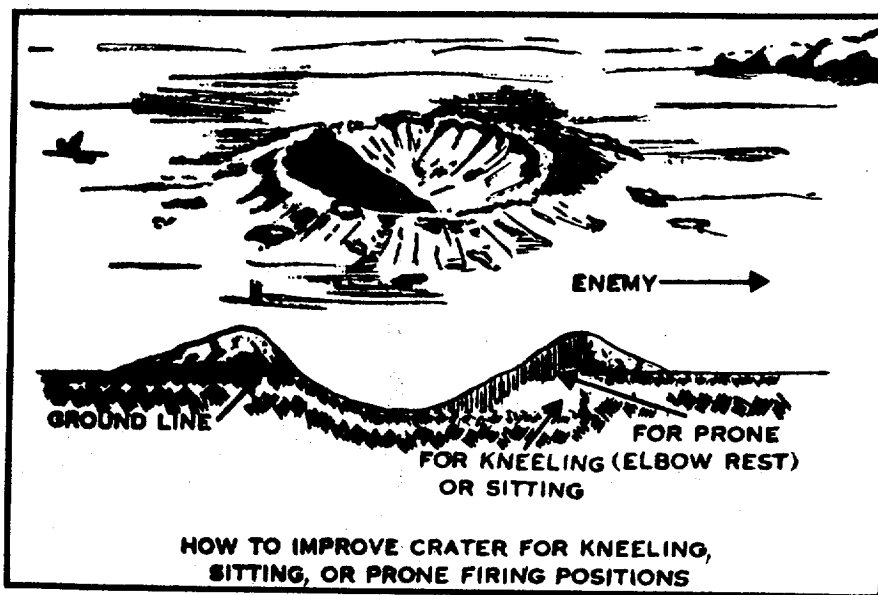

Figure 4-39. Shell Hole Hide.

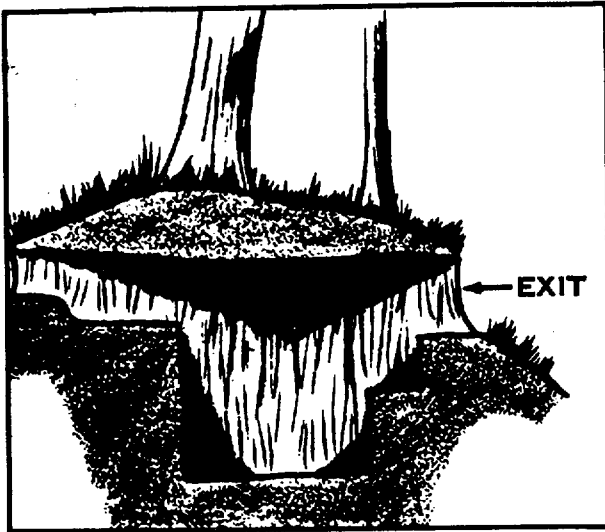

Figure 4-40. Tree or Stump Hide
(Cutaway Showing Exits).



Figure 4-41. Tree Hide
(Cutaway).

TREE OR STUMP HIDES

In selecting trees for a hide, trees should be used that have a good deep root, such as oak, chestnut, or hickory. During heavy winds, these trees tend to remain steadier than pines which have a surface root system. A large tree should be used that is in back of the tree line. This may limit the field of view, but it will afford better cover from enemy observation.

POSITIONS IN A BUILT-UP AREA

There are two types of firing positions utilized in a built-up area—hasty and prepared.

HASTY

A hasty position for a sniper, in a built-up area, may be occupied voluntarily, or the sniper may be forced to occupy it because of enemy presence and fire. In the offensive, the sniper can operate with the covering party to deliver accurate fires in support of the search party. In this mode of support, the sniper will occupy a hasty position.

Some common hasty positions are:

- Corners of buildings.
- Firing from behind walls.
- Firing from windows. (The sniper does not hang out the window, but he stays back in the shadows of the room).

- Firing from unprepared loopholes.

An unprepared loophole is nothing more than a hole in the wall of a building to fire through. In this type firing, the sniper is well back from the loophole to prevent the muzzle of the weapon from protruding beyond the wall and to conceal the muzzle flash of the weapon. It also provides good cover and concealment.



Figure 4-42. Sniper Firing From an Unprepared Loophole.

- Firing from the peaks of a roof.

The peak of a roof provides a vantage point for snipers to increase their field of vision and the range at which they can engage targets. The sniper in figure 4-43 is failing to take maximum advantage of the available cover.

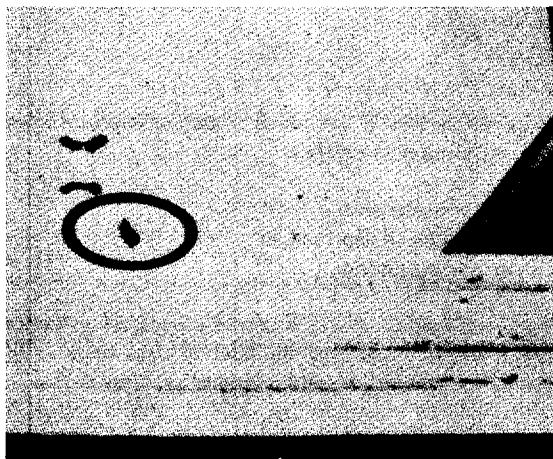

Right

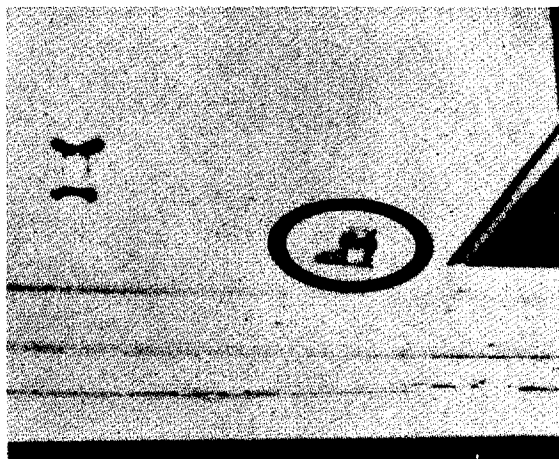

Wrong

Figure 4-43. Sniper Firing From Peaks of a Roof.

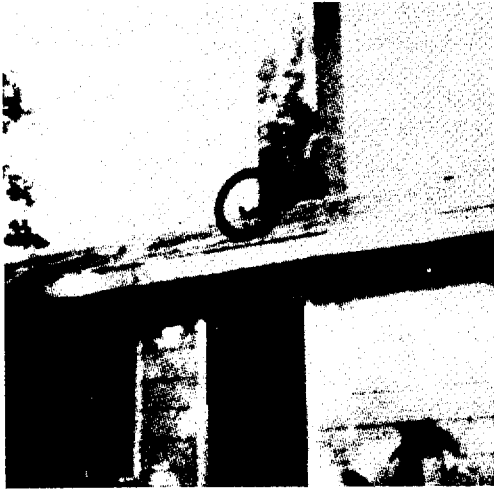

A chimney, smokestack, or any other object protruding from the roof can be used as a hasty firing position.

Figure 4-44. Sniper Firing From the Side of a Chimney.

- Firing from doorways.
- Firing from and inside of battle rubble, trash, or debris.

PREPARED

A prepared position is one which is built, or improved upon, to allow the sniper to engage a:

- Particular area,
- Avenue of approach, or
- Enemy position.

A prepared position (hide) is normally occupied in the defense of certain locations within built-up areas. Some of the places for preparing "prepared positions" are below.

Windows

The natural firing position provided by windows can be significantly improved for firing positions. The barricading may be accomplished with materials torn from the interior walls of buildings or any other available material, such as old mattresses or furniture.

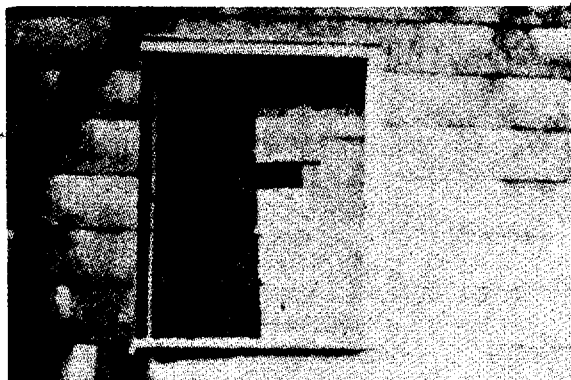

A

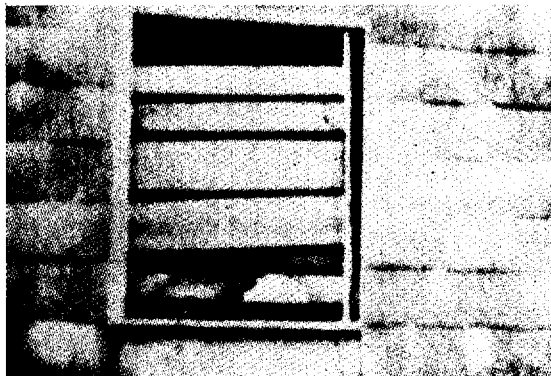

B

Figure 4-45. Window Positions.

When building a hide in a window, the sniper **MUST** avoid:

- Barricading only the windows from which the sniper intends to fire.
- Neat, square, or rectangular holes. This type of hole will be easily identified by the enemy.

Figure 4-45 (A) shows a barricaded window with a neat, regular loophole. The window loophole in figure 4-45 (B) is much more difficult to find. By leaving an irregular shaped loophole at the bottom of the window, the sniper gains cover for most of his body from the wall, and the position is less obvious to the enemy. Sandbags are used to reinforce the wall below the window and increase the protection for the sniper.

Hides from windows, back in the shadows, can also be considered without barricading from within the room. These are called "urban" hides. Camouflaged netting can be utilized

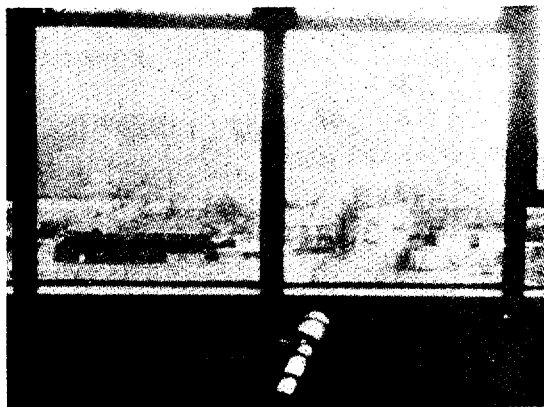

Figure 4-46. Urban Hide.

Buildings

Although windows normally provide good firing positions, they will not always allow the sniper to engage targets in his assigned sector. Also, to avoid establishing a pattern of always firing from windows, other locations for firing positions must be found. One that can be selected and made into a firing position is the corner or side of a building as shown in figure 4-47. A loophole is cut or blown in the wall to allow the sniper to fire or observe. Sandbags are used to reinforce the walls below, around, and above the loophole. Care should be taken to camouflage this type of hide. This is accomplished by utilizing dummy holes in the building to make it more difficult to determine which loophole the sniper fire is coming from. These dummy holes will also provide the sniper with alternate positions. The siding material should be removed from the building in several places to make the loopholes less noticeable.

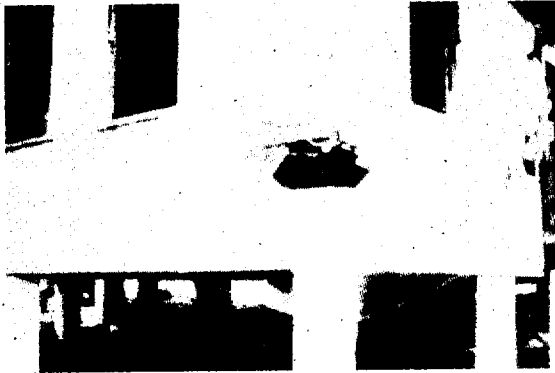

Figure 4-47. Firing Position in Corner of Building.

Chimney

A chimney or other structure protruding through the roof of a building provides a base from which a sniper position (hide) can be prepared. Part of the roofing material is removed to allow the sniper to stand in a supported position inside the building (on the rafters or a platform) with only his head and shoulders above the roof (behind the chimney). From here the sniper can fire around the chimney.

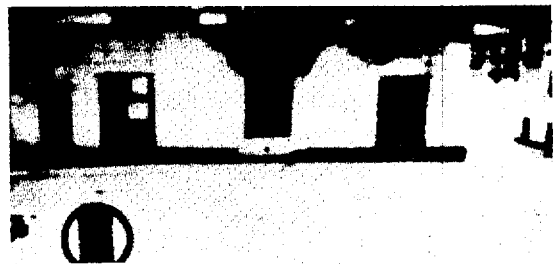

Figure 4-48. Sniper Firing From a Prepared Position Behind a Chimney.

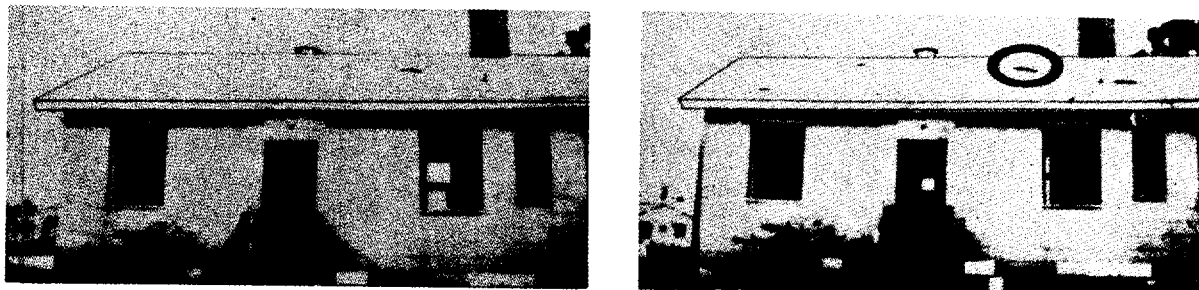

Figure 4-49. Construction of Roof Position.

Rooftops

When preparing a sniper position (hide) on a roof which has no structure protruding to provide protection, the position should be prepared from underneath on the ENEMY side of the roof. A few small pieces of roofing material should be removed to allow the sniper to engage targets in his sector of responsibility. The position is supported and reinforced with sandbags and prepared so that the only visible sign that a position exists is the missing pieces of roofing material. No portion of the sniper's body is visible from outside the building. Care must be taken to prevent the muzzle of the weapon, or the muzzle flash, from being seen from outside the building.

Other Locations

Some other possible locations for prepared positions are:

- Street level vents or barred windows from basements.
- Vents on attic levels from sides of houses.

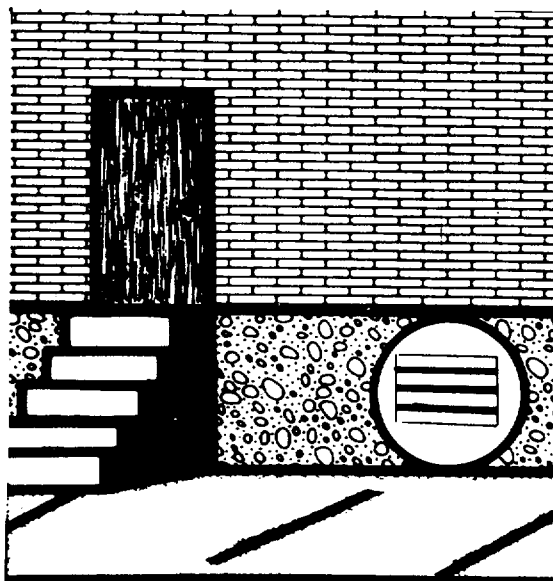

Figure 4-50. Basement Level Hide.

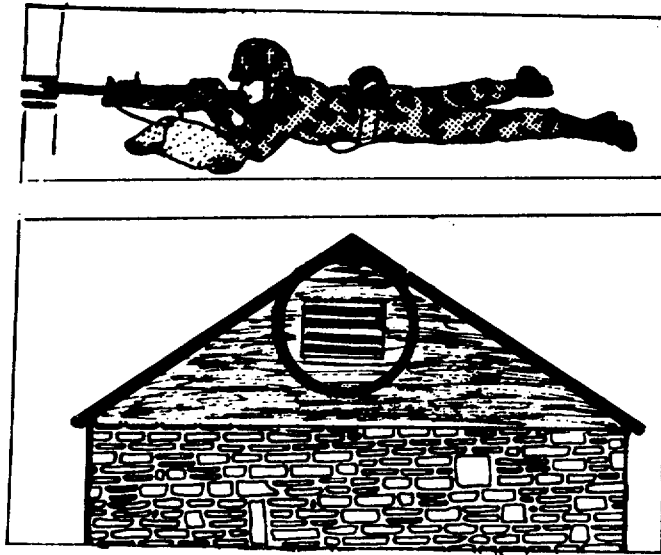

Figure 4-51. Attic Level Positions.

GENERAL RULES AND CONSIDERATIONS

Some general rules and considerations for selecting and occupying sniper positions (hides) are:

- Make maximum use of available cover.
- Avoid silhouetting against light-colored backgrounds.
- New firing positions must be carefully selected before occupation.
- Keep exposure time to a minimum.
- Avoid setting a pattern.
- Do not fire continually from barricaded windows.
- Never fire from unbarricaded windows unless the hide is constructed back in the shadows of the room.

Selection of a well covered and concealed position is not a guarantee of the sniper's safety. He must remain alert to danger and self-betrayal and not violate the following security precautions:

- When the situation permits, a sniper position from which to observe and shoot is selected and constructed. The slightest movement is the only requirement for detection; therefore, even during the hours of darkness, caution must be exercised as the enemy may employ night vision equipment, and sound travels great distances at night.

POSITION SAFETY

- The sniper should not be located against a contrasting background or near prominent terrain features. These are usually under observation or used as registration points.
- In selecting a position, those areas that are least likely to be occupied by the enemy are considered.
- The position must be located within effective range of the expected targets and must afford a clear field of fire.
- Where necessary, alternate positions are constructed or employed to effectively cover an area.
- It must be assumed that, at all times, the sniper position is under enemy observation. Therefore, while moving into position, the sniper team should take full advantage of all available cover and concealment and individual camouflage discipline; i.e., face and exposed skin areas camouflaged with appropriate material. The face veil should completely cover the face, and upon moving into position, the veil should cover the bolt, receiver, and entire length of the scope.
- The sniper team avoids making any sound.
- Unnecessary movement is avoided, unless concealed from observation.
- Observing over a skyline or the top of cover or concealment which has an even outline or contrasting background is avoided.
- The use of binoculars or the telescope where light may reflect from lenses is avoided. Sleeves that extend over the lenses may be constructed from cardboard or garnish.
- The sniper should avoid moving the foliage concealing his position when he is observing.
- When observing from a sniper post within a building, the sniper should stay in the shadows.
- Careful consideration must be given to the route into or out of the position. A worn path can easily be detected. The route should be concealed, and if possible, a covered route acquired.
- When possible, the sniper should choose a position so that a terrain obstacle (ditch, stream bed, dead trees, etc.) lies between it and the target and/or known or suspected enemy location.
- While on the move and, subsequently, while moving into or out of position, all weapons will be loaded with a round in the chamber and the weapon on SAFE (with the possible exception of the sniper rifle, unless the safety of that weapon can be taped in the SAFE position to prevent accidental discharge).

ACTIONS IN POSITION

After arriving in position and conducting their hasty, then detailed searches, the sniper team organizes any and all equipment in a convenient manner so that it is readily accessible, if needed. The sniper team continues to observe and collect any and all pertinent information for intelligence purposes. They establish their own system for observing, eating, sleeping, resting, and making head calls when necessary. This is usually done in time increments of 30 to 60 minutes and worked alternately between the two snipers for the entire time they are in position, allowing one of the individuals to relax to some degree for short periods. Therefore, it is possible for the snipers to remain effective for longer periods of time. The sniper team must practice noise discipline at all times while occupying their position.

SNIPER RANGE CARD

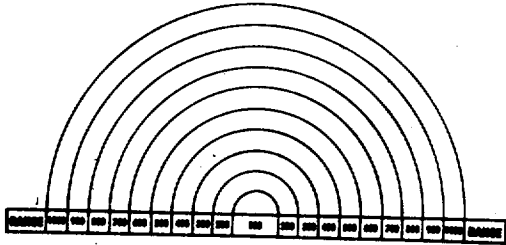

GRID COORDINATE OF POSITIONS _____
 METHOD OF OBTAINING RANGE _____
 MADE OUT BY _____
 DATE _____

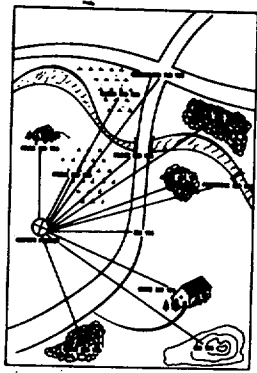

OBSERVATION LOG				
Observer RANDOLPH		Date 8 AUG 60		Sheet 1 of 1
Position 47337E		Time of Day 2000-2400		
Visibility CLEAR				
Serial	Time	Grid Coordinate or / Day and Range	Event	Action or Remarks
87	0730	472334	ENEMY PATROL IN OPEN	CALLED IN AIR STRIKE

SECTION 5

SNIPER SKILLS

501. RANGE CARD, LOG BOOK, FIELD SKETCHING

The primary mission of a sniper is to deliver precision fire on selected targets from concealed positions. His secondary mission is to collect information about the enemy. To do this, he must be observant to locate prospective targets and be able to identify what he sees. However observant, the sniper cannot be expected to remember all the ranges to possible targets or to recall all tidbits of information he may come across. The means designed to assist him in these tasks are:

- The range card.
- The log book.
- Field sketching.

The range card is a handy reference guide which the sniper uses to make rapid, accurate estimates of range to targets which he may locate in the course of his observation.

RANGE CARD

The range card can be reproduced locally, and it is not necessary that the maximum range be 1,000 yards. Depending on the operational mission of the sniper team it may be necessary to extend or decrease the range of observation.

SNIPERS RANGE CARD

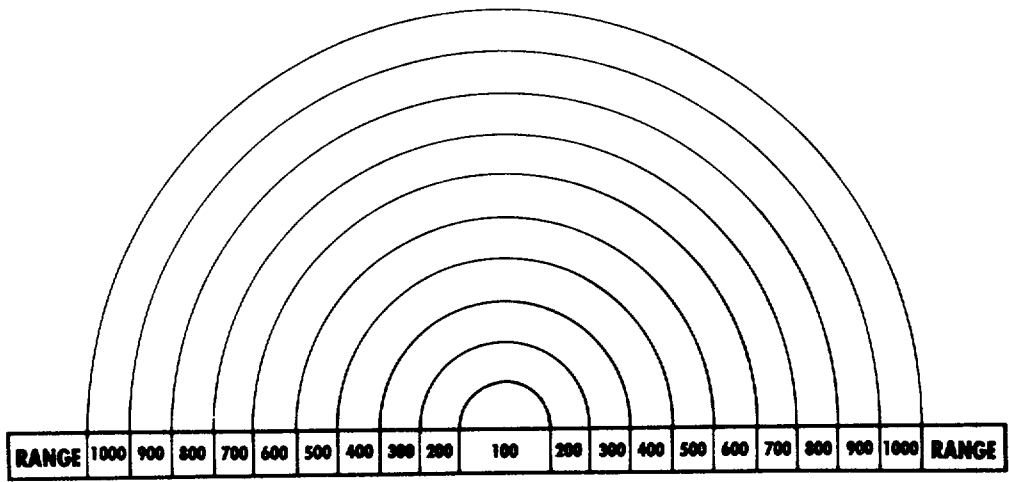

GRID COORDINATE OF POSITIONS _____
METHOD OF OBTAINING RANGE _____
MADE OUT BY _____
DATE _____

Figure 5-1. Range Card.

FIELD EXPEDIENT RANGE CARD

The field expedient range card is drawn freehand after the sniper team's arrival at its point of observation or position.

This type of range card contains the following:

- Relative locations of dominate objects and terrain features such as:
 - Houses
 - Bridges
 - Groves
 - Hills
 - Crossroads
- Carefully estimated, or map measured, ranges to the objects or features on the card.

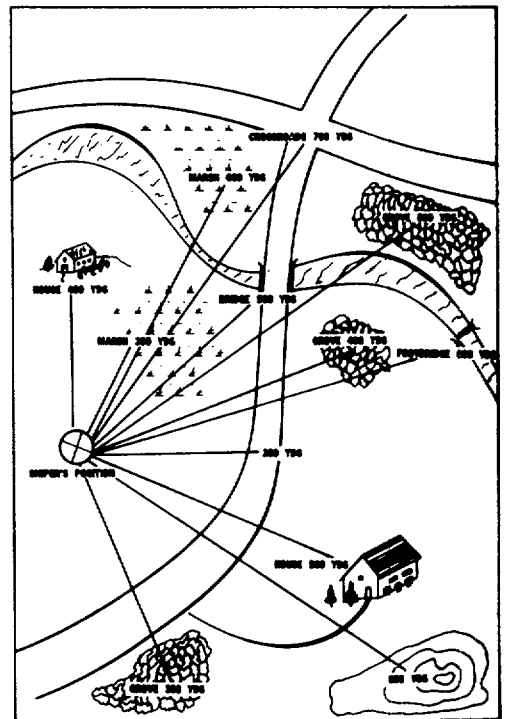

Figure 5-2. Field Expedient Range Card.

PREPARED RANGE CARD

Prior to departure on a mission, the sniper prepares a range card as shown in figure 5-3. The range card can be broken into sectors, as shown, to aid the sniper in locating and engaging targets quickly. Upon arrival in position, the sniper commences a hasty search of the operational area. This is followed by a detailed search in conjunction with the preparation of the range card. Next, the sniper draws in terrain features and dominant objects. All the drawings on the range card are as if the sniper team is looking straight down over the observation area. (See fig. 5-4.) All elevation, relief, and basic military symbols are used.

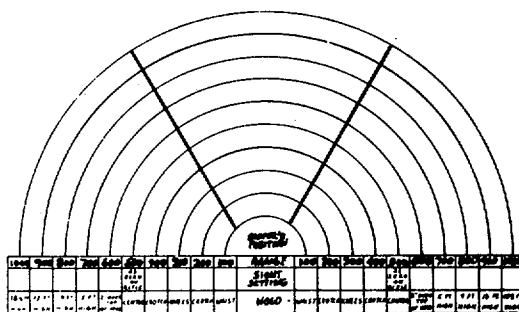

Figure 5-3. Prepared Range Card. (View 1)

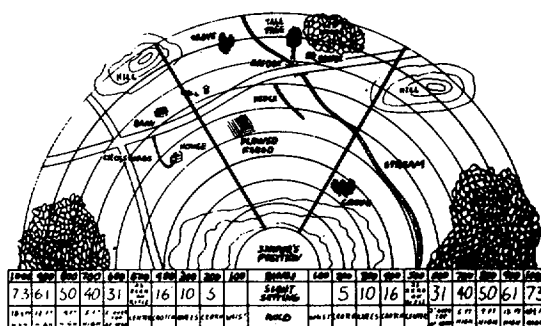

Figure 5-4. Prepared Range Card. (View 2)

(See fig. 5-4.) The observer locates a target at the well in sector "B" at 1100 from their position. From his range card, the observer quickly determines the range to the well (750 yards). The observer announces the location of the target (sector B - 1100 - 750 yards) by arm-and-hand signals, and by pointing to the target on the range card. (Arm-and-hand signals are prearranged and understood by both team members. The sniper then dials 750 on the elevation drum of the scope, dials the windage on the scope (as per the partners instruction), centers the crosshairs on the target's chest, and fires (one shot, one kill).

USE OF RANGE CARDS

OBSERVATION LOG				
Originator <u>RANDOLPH</u>		Date <u>8 AUG 80</u>	Tour of Duty <u>2000-2400</u>	
Position <u>473375</u>		Visibility <u>CLEAR</u>		
Serial	Time	Grid Coordinate GR / Brg and Range	Event	Action or Remarks
37	0902	472334	ENEMY PATROL IN OPEN	CALLED IN AIR STRIKE

Figure 5-5. Observation Log.

OBSERVATION LOG

The sniper log is a factual, chronological record of his employment, which will be a permanent source of operational data. It will provide information to intelligence personnel, unit commanders, other snipers, and the sniper himself.

The log will contain at a minimum the following information:

- Name of observers.
- Hours of observation and date.
- Position (grid coordinates/longitude/latitude).
- Visibility.
- Number of serials (sightings) in chronological order.
- Time of observation.
- Grid reference of observation.
- Event.
- Remarks or action taken.

The sniper log is always used in conjunction with a field sketch. In this way, not only does the sniper have a written account of what was seen, but he also has a pictorial reference showing exactly where he sighted or suspected enemy activity. If the sniper is relieved in place, the new team can easily locate earlier sightings from the observation log and field sketch.

A field (panoramic) sketch is a drawn reproduction of a view obtained from any given point, and it is vital to the value of the sniper's log. As is the case for all drawings, artistic ability is an asset, but satisfactory sketches can be produced by anyone, regardless of artistic skill.

The sniper studies the ground with his naked eye and through the binoculars before putting pencil to paper. Doing so, he decides what is the extent of the country that is to be included in the drawing, and selects the major features which will form the framework of the sketch.

He should not attempt to put too much detail into the drawing. Minor features should be omitted, unless they are of tactical importance. As far as possible, everything is drawn in perspective.

The further away the object is, the smaller it will appear in the drawing. The horizon line is the line formed by the intersection with the ground of a horizontal plane at the height of the sketcher's eye.

FIELD SKETCH (PANORAMIC SKETCH)

GENERAL PRINCIPLES TO FOLLOW

GENERAL PRINCIPLES OF PERSPECTIVE

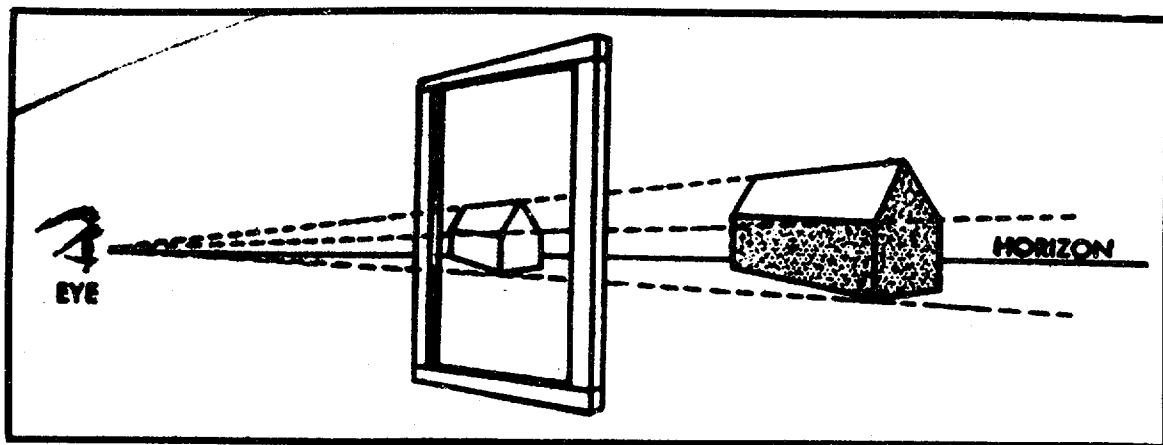

Figure 5-6. Horizon Line.

In level country and over water, the horizon line is coincident with the skyline. In rolling country, the horizon line is a little below the lowest point in the skyline, or where the skyline would be if the country were flat. In figure 5-6, the horizon line is approximately on line with the floor of the building.

VANISHING POINT

Lines which actually are parallel on the ground appear to converge as they recede and, if produced, appear to meet or vanish at a point called the *vanishing point* of that system of parallel lines.

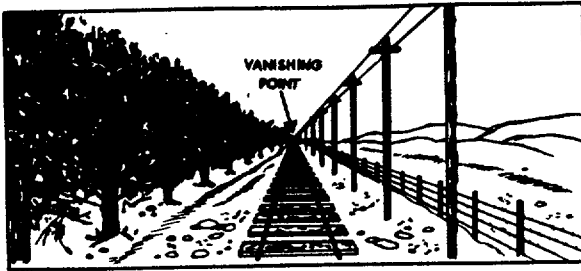

Figure 5-7. Horizontal Parallel Lines.

RULES FOR "VANISHING POINTS"

Parallel lines, which on the ground are horizontal, vanish at a point on the horizon.

Parallel lines, which on the ground slope upward away from the observer, vanish at a point above the horizon.

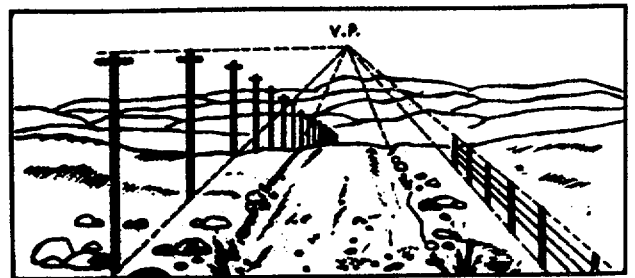

Figure 5-8. Parallel Lines Sloping Upward.

Parallel lines, which on the ground slope downward away from the observer, vanish at a point below the horizon.

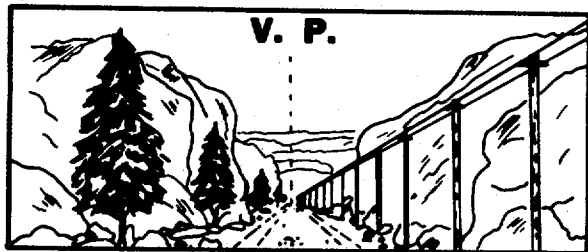

Figure 5-9. Parallel Lines Sloping Downward.

Parallel lines receding to the right vanish to the right; those receding to the left vanish to the left.



Figure 5-10. Receding Parallel Lines.

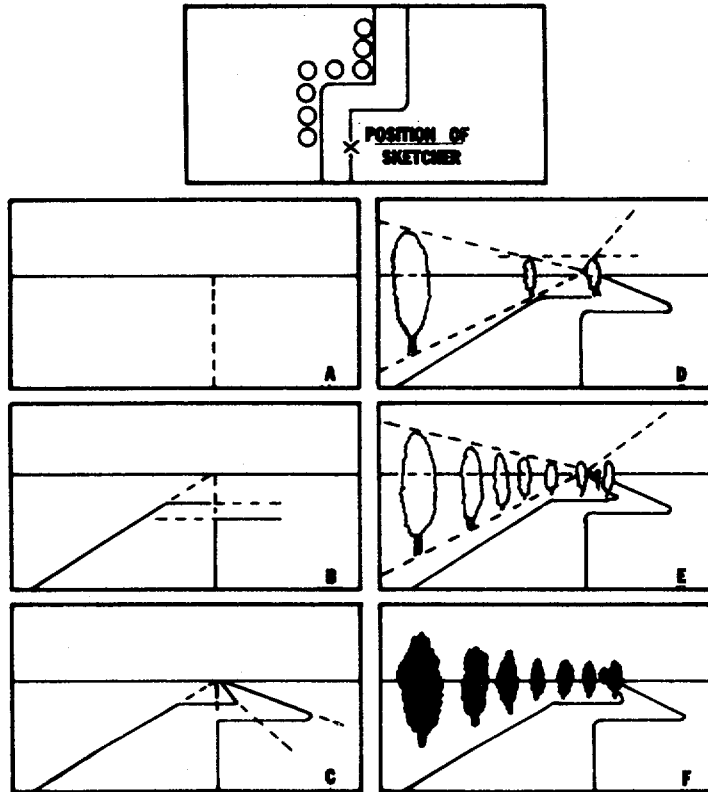

Figure 5-11. Steps in Preparing a Panoramic Sketch of a Road.

The apparent size of any object varies with its distance from the observer. The farther away the object, the smaller it appears to the observer.

The apparent distance between regularly spaced objects vary with their distances from the observer, in the same way the apparent size varies.

STEPS IN PERSPECTIVE DRAWING

The steps in perspective drawing of a section of terrain are illustrated in figure 5-11. This represents a topographic map of a road first extending due north, then east, and then due north again as far as the eye can see over level ground. A row of trees of uniform height borders on the left side of the road, and the sketcher is assumed to be standing at the right side of the road. The figure shows how the sketch is built up in the correct perspective. The two road sections extending north have a common vanishing point in the horizon, and their sides converge very rapidly. The sides of the road extending east remain parallel in perspective, and the heights of the trees along the road are uniform.

DELINEATION

Delineation is the portrayal of objects or features of the landscape as they appear to the observer.

The skyline, crests, and roads form the main "control line" of the sketch and are drawn in first to form a framework within which the details are properly placed.

Features are represented with a few, rather than many, lines. The "effect" of distance is created by making the lines in the foreground *HEAVY*, and distant lines very *LIGHT*.

Full lines are better than broken lines.

Important detail in distance can be drawn heavily or enlarged for emphasis.

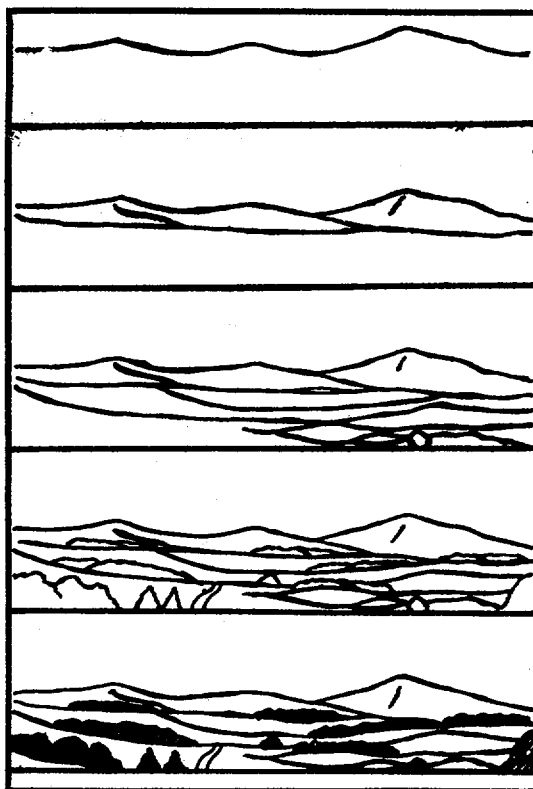
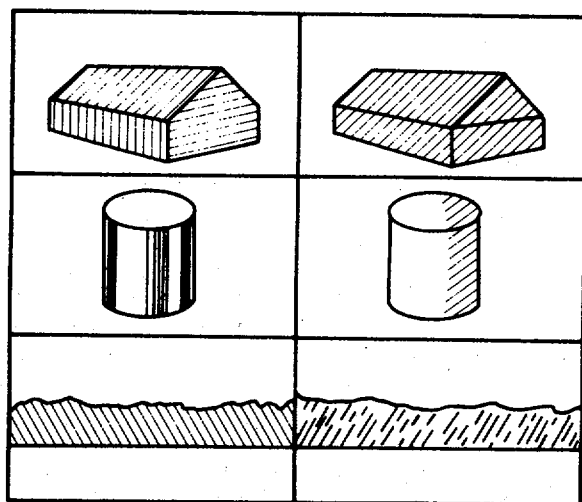

Figure 5-12. Delineation Showing the Order in Which a Sketch is Built Up.



GOOD

POOR

Figure 5-13. Good and Poor Hatching.

A light HATCH may be used to distinguish wooded areas as shown in figure 5-13. Hatching should follow the natural lines of an object.

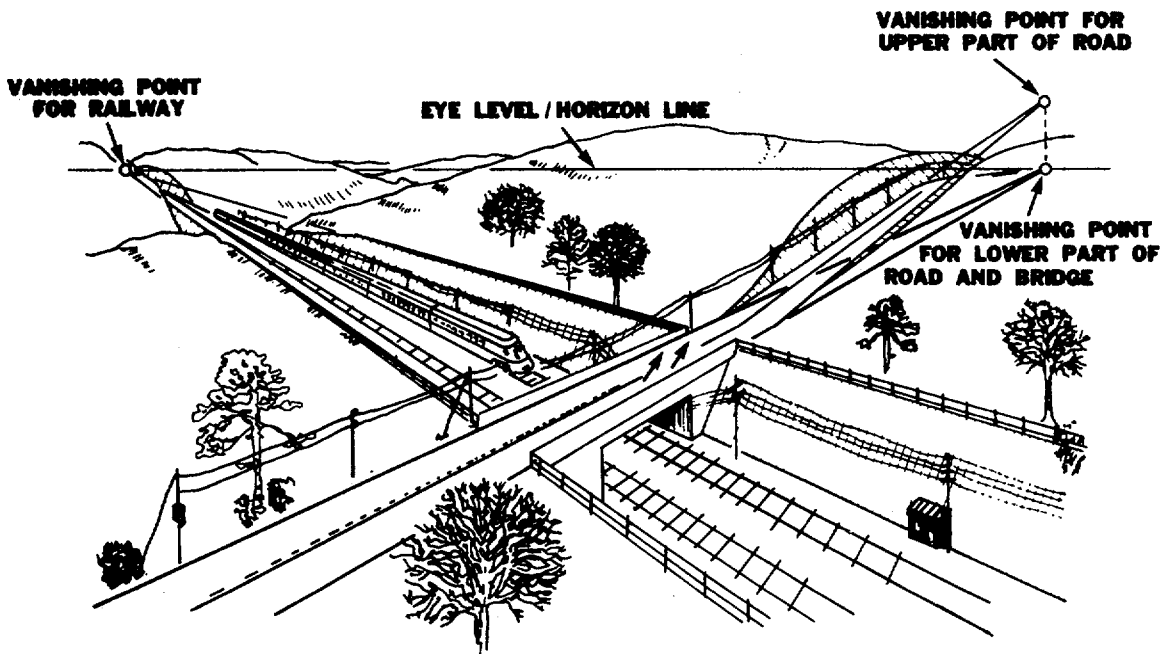

Figure 5-14. Panoramic Sketch.

CONVENTIONAL REPRESENTATION OF FEATURES

PROMINENT FEATURES

The following methods of representing natural objects in a conventional manner should be borne in mind when making the sketch:

The actual shape of all prominent features which might readily be selected as reference points when describing targets, such as oddly shaped trees, outstanding buildings, towers, etc., should be shown if possible. They must be accentuated with an arrow and a line with a description; e.g., prominent tree with large withered branch.

RIVERS

Rivers are shown by two lines diminishing in width as they recede.

TREES

Trees should be represented by outline only. Some attempt should be made to show characteristic shape of individual trees in the foreground.

WOODS

Woods in the distance should be shown by outline only. In the foreground, the tops of individual trees may be indicated; woods may be shaded, the depth of shadowing becomes less woods distance.

ROADS

Roads should be shown by a double continuous line diminishing in width as it recedes.

In the foreground, railways should be shown by a double line with small cross lines (which represent the ties) to distinguish them from roads; in the distance, they will be indicated by a single line with vertical ticks to represent the telegraph poles.

RAILWAYS

Churches should be shown on outline only, but care should be taken to denote whether they have a tower or a spire.

CHURCHES

Definite rectangular shapes denote houses; towers, factory chimneys, and prominent buildings should be indicated where they occur.

TOWNS AND VILLAGES

Cuts and fills may be shown by the usual topographic symbols, ticks diminishing in thickness from top to bottom, and with a firm line running along the top of the slope in the case of a cut.

CUTS AND FILLS

Swamps and marshland may be shown by conventional topographic symbols.

SWAMPS AND MARSHLAND

GRID WINDOW

OTHER METHODS OF FIELD SKETCHING

A simple device which can help a great deal in field sketching can be made by taking a piece of cardboard or hard plastic and cutting out, from the center, a rectangle 6 inches by 2 inches. A piece of clear plastic sheeting or celluloid is then pasted over the rectangle. A grid of $\frac{1}{2}$ -inch squares is drawn on the plastic sheeting. The sheeting now becomes a ruled plastic window through which the landscape can be viewed. The paper on which the drawing is to be made is ruled with a similar grid of squares. If the frame is held at a fixed distance from the eye by a piece of string held in the teeth, the detail seen can be transferred to the paper square by square.

COMPASS METHOD

Another method is to divide the paper into sections by drawing vertical lines denoting a fixed number of mils of arc from the sniper location and plotting the position of important features by taking compass bearings to them. This method is accurate but slow. Distance arcs can also be constructed as on the range card.

502. COLLECTION AND REPORTING OF INFORMATION

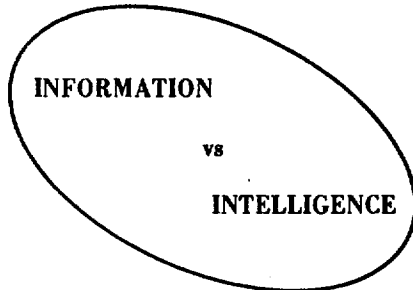

INFORMATION is the unevaluated material of every description including that derived from:

- Observation
- Communications
- Reports
- Rumors
- Imagery
- Other sources from which intelligence is produced

INTELLIGENCE is the product resulting from the collection, evaluation, and interpretation of information which concerns one or more aspects of foreign nations or of functional or geographic areas, and which is immediately or potentially significant to the development and execution of plans, policies, and operations.

COMBAT INTELLIGENCE

Combat intelligence is that knowledge of the enemy, weather, and geographical features required by a commander in the planning and conduct of combat operations.

Combat intelligence is derived from the interpretation of information on the enemy (both his capabilities and vulnerabilities) and the environment.

The objective of combat intelligence is to minimize uncertainty concerning the effects of those factors listed above, on the accomplishment of the mission, and maintaining the security of the command.

COMMANDERS INTELLIGENCE REQUIREMENTS

Intelligence requirements generally can be divided into two broad categories—essential elements of information (EEI) and other intelligence requirements (OIR).

EEI

EEI are those critical items of information regarding the enemy and the environment needed by the commander, by a particular time, to relate with other available information and intelligence to assist him in reaching a logical decision. Care must be taken to limit the EEI to only those most critical items of information.

OIR

OIR is the collection of information on other capabilities, vulnerabilities, and characteristics of the area of operations which may affect the accomplishment of the mission.

OIR are derived from command requirements which do not qualify as EEI, and from staff requirements.

The formulation and/or announcement of intelligence requirements and the allocation of collection means to meet these requirements are staff responsibilities of the intelligence office.

Areas of intelligence operations are assigned to units on the basis of areas of influence and areas of interest.

GEOGRAPHICAL AREAS OF INTELLIGENCE OPERATIONS

AREA OF INFLUENCE

Area of influence is that portion of the assigned zone or area of operations in which the commander is capable of directly affecting the course of combat by the employment of his own available combat power.

The area of influence can extend in any direction from the forward disposition of the command, the significant direction and dimension is that which extends forward from the FEBA.

The limit of the area of influence is set by the effective range of the available weapons systems since a commander will not normally maneuver the subordinate elements of his command beyond the range of the supporting fires available to him.

AREA OF INTEREST

Area of interest is that area from which information and intelligence are required to permit planning for the extension of the area of influence or for the displacement of potential targets into the area of influence.

IMMEDIATE ZONE

Immediate zone is the area bounded by the distance which a commander must have immediate knowledge of an enemy presence in order to act effectively when the enemy reaches the area of influence.

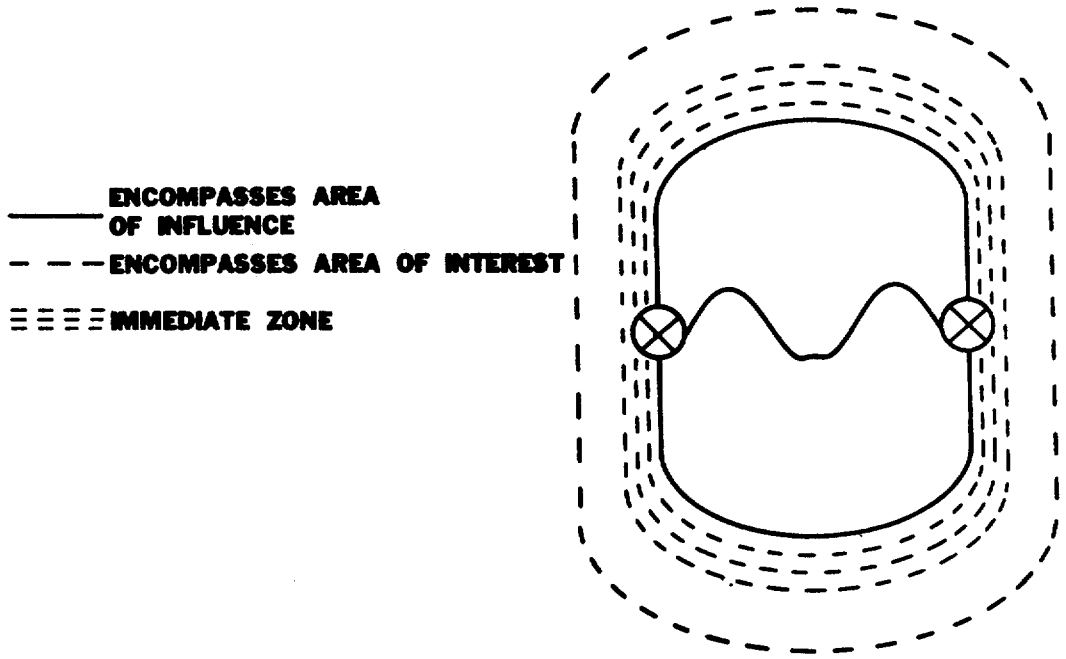
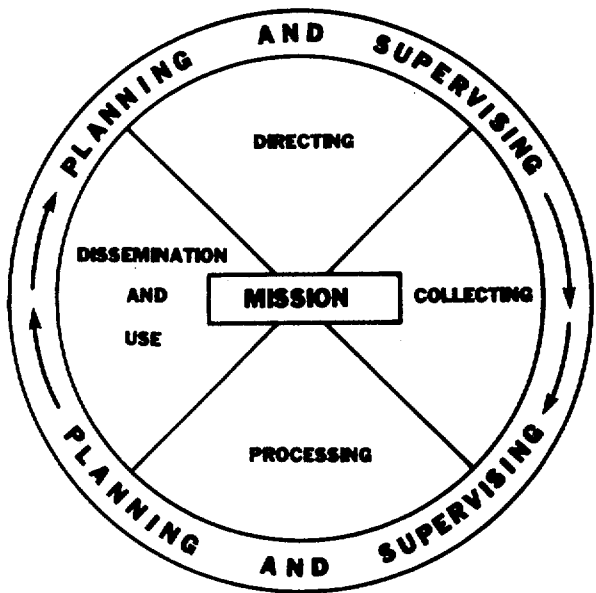

Figure 5-15. Relationship of Area of Influence, Area of Interest, and Immediate Zone.



INTELLIGENCE CYCLE

FOUR PHASES:

1. Directing the collection effort.
2. Collecting the information.
3. Processing the collected information.
4. Disseminating and using the resulting intelligence.

Figure 5-16. Intelligence Cycle.

In the attack, avenues of approach which lead from the line of departure to key terrain are selected for analysis. The best avenues of approach to the objective are identified for the friendly forces.

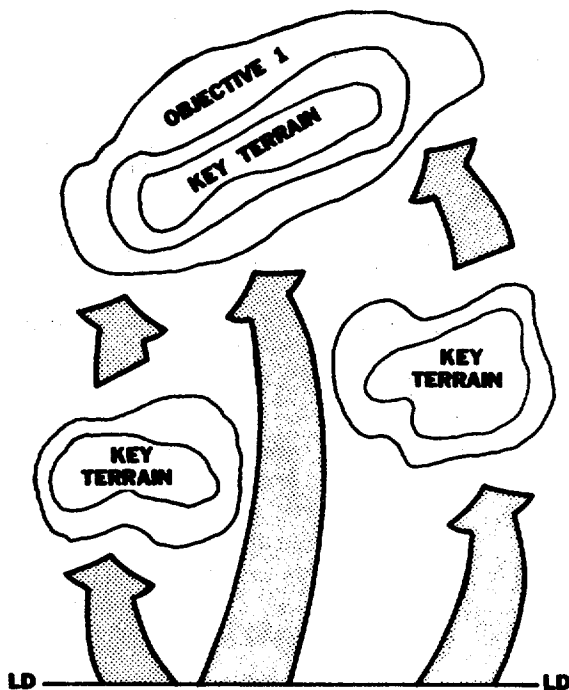

Figure 5-17. Areas Selected for Analysis in Offense.

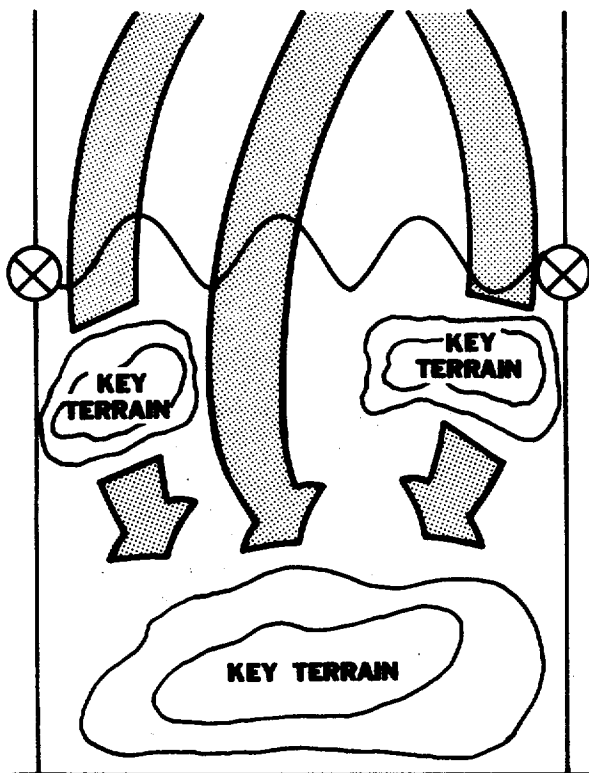

Figure 5-18. Areas Selected for Analysis in Defense.

In the defense, avenues of approach available to the enemy are selected for identification and analysis.

**INTELLIGENCE REQUIREMENTS
FOR THE
ATTACK**

Most of the commander's initial requirements must be satisfied during the planning phase so that plans can be properly formulated. Subsequent requirements, that is, information which is needed during the attack, must provide the basis upon which the commander can decide the proper time and place for the commitment of his reserves, employment of supporting weapons or units, and modification of his operation plan.

SPECIFIC REQUIREMENTS FOR THE PLANNING PHASE OF THE ATTACK:

**LOCATION, TYPE, STRENGTH, AND
MORALE OF ENEMY UNITS ON LINE
AND IN RESERVE**

**LOCATION, TYPE, AND
STRENGTH OF ENEMY RESERVES**

LOCATION OF COMMAND POSTS

ENEMY VULNERABILITY TO COVER AND DECEPTION

AVENUES OF APPROACH

**LOCATION, NUMBER, AND
TYPES OF ENEMY
SUPPORTING WEAPONS
(CREW-SERVED WEAPONS)**

**ESTIMATE OF ENEMY
PLANS AND CAPABILITIES**

WEATHER AND TERRAIN

LOCATION OF OBSTACLES

LOCATION OF ENEMY OUTPOSTS

**LOCATION, NUMBER, AND TYPES OF ENEMY
CHEMICAL, BIOLOGICAL, OR NUCLEAR
WEAPONS, AND THE METHOD OF DELIVERY**

ENEMY OBSERVATION CAPABILITIES

**LOCATION, TYPE, NATURE, AND EXTENT
OF ENEMY DEFENSIVE INSTALLATIONS,
TO INCLUDE SUPPORTING WEAPONS,
SCREENING UNITS, AND OBSTACLES**

COVER AND CONCEALMENT

LOCATION OF ENEMY BOUNDARIES

**LOCATION, NUMBER, AND TYPE OF ENEMY
AUTOMATIC WEAPONS**

**KNOWLEDGE ON ENEMY'S COMMAND, CONTROL
AND COMMUNICATIONS**

**LOCATION AND TYPES OF
ENEMY TARGET ACQUISITION
SYSTEMS**

**ENEMY'S ELECTRONIC COUNTERMEASURE
CAPABILITIES**

REQUIREMENTS DURING THE ATTACK:

MOVEMENT OF ENEMY UNITS

**ENEMY EXPENDITURE OF AMMUNITION AND
RESUPPLY ACTIVITIES**

DEGREE OF RESISTANCE OF ENEMY UNITS ON CONTACT

DISPLACEMENT OF ENEMY WEAPONS

ENEMY'S INTELLIGENCE ESTIMATES

**ENEMY'S COMMAND, CONTROL, AND
COMMUNICATIONS**

**INTELLIGENCE REQUIREMENTS
FOR DEFENSE**

In the defense, many of the factors (e.g., weather, terrain, and enemy situation) included in planning for an attack are considered; however, most of the factors take on a new meaning and must be interpreted in a different light. Whereas heavy rain may impede an attack, the rain may be an aid in defense because of its adverse effect on the enemy's capability to attack.

SPECIFIC REQUIREMENTS FOR THE PLANNING PHASE OF THE DEFENSE:

WEATHER AND TERRAIN

ENEMY'S COMMAND, CONTROL, AND COMMUNICATIONS

DISPOSITION, STRENGTH, AND MORALE OF ENEMY UNITS IN CONTACT, IN RESERVE, OR IN POSITION TO INFLUENCE THE ACTION (POSSIBLE ASSEMBLY AREAS)

LOCATION OF POTENTIAL ENEMY ASSEMBLY AREAS

LOCATION OF ENEMY BOUNDARIES

ENEMY PLANS AND CAPABILITIES

LOCATION AND TYPES OF ENEMY SUPPORTING WEAPONS

ENEMY'S VULNERABILITY TO COVER AND DECEPTION

AVENUES OF APPROACH

LOCATION AND TYPE OF ENEMY TARGET ACQUISITION SYSTEMS

LOCATION OF NATURAL AND ARTIFICIAL OBSTACLES

OBSERVATION AND FIRE

ENEMY'S ELECTRONIC COUNTERMEASURES

NUMBER AND ROUTES OF ENEMY RECONNAISSANCE AND/OR COMBAT PATROLS

REQUIREMENTS DURING THE DEFENSE

AREAS OF ENEMY'S MAIN ATTACK AND SECONDARY ATTACKS

ENEMY TACTICS

COMMAND, CONTROL, AND COMMUNICATIONS

ENEMY INTELLIGENCE COLLECTION ESTIMATES

A source is a person, thing, or activity from which information is originally obtained that may or may not be under friendly control. Snipers will gather information while en route to the objective, at the objective, and back to the friendly unit, through surveillance, reconnaissance, and target acquisition.

SOURCES OF INFORMATION

COMMON SOURCES

- Enemy activities.
- Prisoners of war.
- Local residents (mission planning).
- Refugees (mission planning).
- Evacuees (mission planning).
- Recovered U.S. military personnel (mission planning).
- Captured enemy documents and material.
- Sounds; odors; duds; shells; missile fragments; craters; areas contaminated by chemical, biological, and radiological warfare; maps; and weather forecasts.

SURVEILLANCE

Surveillance is the all-weather, day and night, systematic observation of the battlefield for intelligence purposes. Surveillance is a continuous watch and does not focus on a specific objective.

RECONNAISSANCE

Reconnaissance is a mission undertaken to obtain information about the activities or resources of an enemy or potential enemy. Reconnaissance is finite in scope and time and has a specific objective.

TARGET ACQUISITION

Target acquisition is the detection, location, and identification of a target with sufficient accuracy and detail to permit the effective employment of weapons.

En route to the hide, or a firing position from friendly lines, the sniper may find it difficult to record information. The Kim's game (discussed in paragraph 4, appendix B) will strengthen the mind to remember, in detail, information obtained. If time permits, a rapid field sketch is drawn and entries recorded on an observation card, as well as recording changes to maps.

Once in the hide or the final firing position, the sniper team will start recording by drawing a field sketch of the area to be observed, preparing a range card, and starting an observation log. Information observed should be described in detail. Hard to explain items should be sketched.

An intelligence journal should be kept on the order of battle and terrain analysis to be utilized by the sniper in his debrief and if he should operate in the same area in the future. All missions should be detailed in the personal journal. Continued referral to an updated sniper journal can provide the sniper and his commander with a detailed insight into the enemy mind, actions, and possible future reactions.

**ORDER
OF
BATTLE**

Order of battle is the identification, strength, command structure, and disposition of the personnel, units, and equipment of any military force. Complete order of battle data is not normally furnished the commander, instead, he is provided *conclusions, estimates, or analyses of enemy probable courses of action based on order of battle information.*

Order of battle consists of evaluated information regarding the following elements:

COMPOSITION

DISPOSITION

STRENGTH

TRAINING STATUS

TACTICS

LOGISTICS

COMBAT EFFECTIVENESS

MISCELLANEOUS DATA

**TERRAIN
ANALYSIS**

AVENUES OF APPROACH

HIGH AND LOW GROUND

SWAMPS, WATER, AND ELEVATED LAND FEATURES

VEGETATION (WOODED, GRASS, OR OPEN AREAS)

MANMADE AND NATURAL FEATURES

**LIKELY ENEMY POSITIONS AND
AZIMUTH TO THE POSITION**

By covering the order of battle and terrain analysis, the commander will be able to fulfill the command requirements: essential elements of information and other intelligence requirements.

A shell report is reported when there is activity by enemy artillery, mortars, and bombs. The report may be given orally or written.

SHELL REPORT

IDENTIFICATION

OBSERVER'S LOCATION

AZIMUTH TO THE ENEMY'S GUN

TIME SHELLING STARTED

COORDINATES OF THE AREA

NUMBER AND TYPES OF WEAPONS FIRED

NATURE OF FIRE (i.e., destruction, harassing, registration, etc.)

NUMBER AND TYPES OF SHELLS FIRED

FLASH-BANG TIME IN SECONDS

DAMAGE

SALUTE REPORT

S ize
A ctivity
L ocation
U nit/uniform
T ime
E quipment

The debriefing is generally performed by an S-2 representative. All members of the sniper team/security elements should be present. The debriefing should be conducted as soon as the snipers return from the mission. All field sketches, observation logs, range cards, and intelligence journals will be present at the debriefing.

DEBRIEFING

A terrain model (sandtable) should be made, if time permits, prior to the operation for planning purposes. Changes (differences in the maps and what is actually found on the ground) should be made on the sandtable prior to the debriefing.

The sandtable is used to brief about the terrain and the route to and from the objective.

The sniper teams must always keep in mind that they have a *secondary mission of gathering information* for intelligence purposes in support of the *sniper mission* and *the mission of the supported infantry unit, but always* in conjunction with the long range precision sniper fire capability.



SECTION 6

SNIPER TACTICAL EMPLOYMENT

601. GENERAL

The sniper is a Marine, highly trained in field skills and marksmanship, who delivers long-range precision fire at "selected targets," from concealed positions. These "selected" targets set him apart from the ordinary rifleman. The method by which snipers are employed will be governed by many factors, such as the nature of the terrain, weather, and distance between forward troops and the enemy, degree of initiative shown by the enemy, general nature of combat, number of snipers available, and whether or not the enemy employs snipers.

The sniper is a highly specialized supporting arm and the sniper teams (two men) should be employed independently, when at all possible, to take full advantage of their skills and to increase their probability of survival. The sniper should continue to move so as to keep the enemy off balance, and should ordinarily take no more than three "selected" shots at any one position. The sniper cannot be utilized to his full potential when he operates directly with the supported infantry unit. The sniper should not be used as just another rifleman. He should maintain freedom of action at all times. His mission, movement, location, and targets should be described in only the most general terms by the supported infantry commander. The principles of sniper employment must be applied with imagination and guided by a commander's sound grasp of the sniper team's capabilities.

CONCEPT OF EMPLOYMENT

COMMON SENSE IS THE GUIDELINE
OF EMPLOYMENT

In turn, the snipers must know the commander's scheme of maneuver and fire support plan in order to best advise him on how the sniper team should be employed.

When utilized correctly, the Marine sniper will prove to be an invaluable tool on the modern battlefield.

Effective sniping will do more than inflict casualties and cause inconvenience to the enemy. It will have a marked effect on the feeling of security and morale of the enemy troops.

Snipers will enable the infantry to be everywhere at once, regardless of whether the terrain is physically occupied by the infantry at the time.

With their advanced techniques of silent, undetectable movement (stalking), camouflage (ghillie suits), positions (hides), and their ability to disappear instantly, there is little chance of the enemy knowing they are there until it is too late.



Figure 6-1. Sniper Team Stalking.



Figure 6-2. Sniper Team in Final Firing Position.



Figure 6-3. Two Snipers in Semipermanent Hide.

Their advanced optical gear and observation techniques let the snipers see the terrain in much more detail than normal infantry troops in any condition. They will be able to detail enemy positions and traces of their activities that would not normally be seen.



Figure 6-4. Sniper Set Up for Observation.

SCOPE

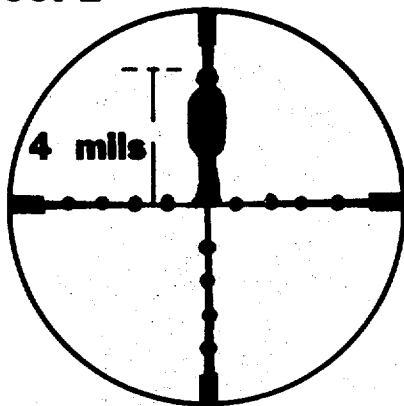

Figure 6-5. Reticle of Scope.

Their advanced techniques of range estimation will allow extreme accuracy and a high degree of proficiency in the control of fire support, in the quest of first-round fire for effect.



Figure 6-6. Sniper Team Briefing Battalion Commander.

With their map reading and aerial photo knowledge, the sniper team will be able to brief the supported commander on the terrain over which they pass and detail any changes, obstacles, and likely avenues of approach.

The sniper will disrupt enemy movement, observation, infiltration, and negate the possibility of surprise. The Marine scout-sniper will be both the "eyes" and "trigger finger" of the infantry and will have a profound effect on the enemy's confidence and fighting spirit.



Figure 6-7. Sniper Viewing Through M49 Scope.



Figure 6-8. Reticle Superimposed.

602. OFFENSIVE COMBAT

In keeping with the fundamentals of offensive combat, the snipers should be used to gain and maintain contact with the enemy. This enhances security and prevents surprise. They will keep constant unrelenting pressure on the enemy, day and night. They will not allow the enemy to regroup effectively or to set up an orderly withdrawal.

EMPLOYMENT OF THE SNIPER

The sniper will:

- Keep the enemy off balance.
- Prevent surprise on the main body.
- Ensure that the supported infantry commander will be able to act rather than react.
- Allow the commander to achieve surprise and not predictability.

The sniper is best utilized when he is sent into the area of planned offensive action ahead of time, preferably under the cover of darkness, to gather timely intelligence data and to "select" his targets.

As the "eyes" of the commander, the sniper increases his flexibility through the gathering and transmitting of intelligence. The sniper will:

- Analyze the terrain according to KOCOA and predict the effects weather will have on both terrain and tactics.

How does weather affect terrain? *Trafficability.*

How does weather affect tactics? *Visibility.*

- Analyze the enemy SALUTE, his capabilities, and his possible reactions to future offensive operations based on terrain, weather, and the enemy himself.

- Suggest modifications of proposed offensives based on educated survey, broadcast advanced warning on enemy reactions and unforeseen developments, and provide information on enemy security, patrolling activities, and defensive positions.

K ey terrain
 O bservation
 C over and concealment
 O bstacles
 A venue of approach

S ize
 A ctivity
 L ocation
 U nit
 T ime
 E quipment

D efend
 R einforce
 A ttack
 W ithdraw
 -
 D elay



Figure 6-9. Sniper Team Directing Supporting Arms Fire.

As the “*trigger finger*” of the infantry, the sniper will select key targets for reduction immediately prior to or during the offensive. He takes out those targets that will have a profound effect on the enemy’s ability to wage battle and those that will cause the maximum amount of confusion on the battlefield. He will eliminate such targets as:

- Enemy officers.
- SNCO’s or NCO’s.
- Crew served weapons, personnel, or equipment.
- Communications.
- Observation equipment.

Hopefully, the enemy will not be able to replace these targets in the confusion of battle and in the presence of the sniper’s continued accurate fire. *He will also direct supporting arms fire on known enemy concentrations, buildups, and equipment which could endanger the mission.* These fires should be preplanned by the sniper prior to the commencement of the assault; scheduled fires are planned when possible.

The snipers can also be used to protect the flanks or rear of the attacking unit, or be used in the rear of the enemy positions to disrupt withdrawals and counterattack plans.

FRONTAL ATTACK

When attacking cross-compartment, the snipers move into a position to dominate the terrain between the limiting features. The snipers move into the area of planned offensive action, between the line of departure and the objective, well ahead of the time of attack. At the moment of decision, they reduce key targets on the objective.

Snipers can also be used to protect the flanks or to seal off the enemy rear.

A less desirable method of employment is to have the snipers provide overhead fires on the objective as this can be best accomplished by the machineguns.



Figure 6-10. Sniper Team Overlooking Enemy Defensive Position.

SINGLE ENVELOPMENT

Snipers:

- o Prevent enveloping force from coming up long or short of the objective.
- o Increase the commander's chances of surprise.

Snipers can greatly increase the probability of success of this most difficult form of maneuver. They can prevent the enveloping force from getting lost or from coming up long or short of the objective, and increase the chances of surprise by giving accurate intelligence on the route, enemy positions, ambush sites, fortifications demolitions, and enemy security activities along the route. When operating with the base of fire, it will not always be necessary for the snipers to shift their fires when they become masked, due to their pinpoint accuracy.

There are several methods of employing the snipers in an envelopment (see fig. 6-11):

- o The snipers move into a position of terrain with good fields of fire on the objective (not necessarily at the line of departure, but adjacent to or to the rear of the objective) and direct the base of fire along a concealed route (infiltration) into the selected position (coincidental with the movement of the enveloping force towards their tentative final coordination line). At a predetermined time (just prior to or coincidental with the assault by the enveloping force), the snipers open fire on selected targets on the objective while the base of fire provides effective fire on the entire objective (A).

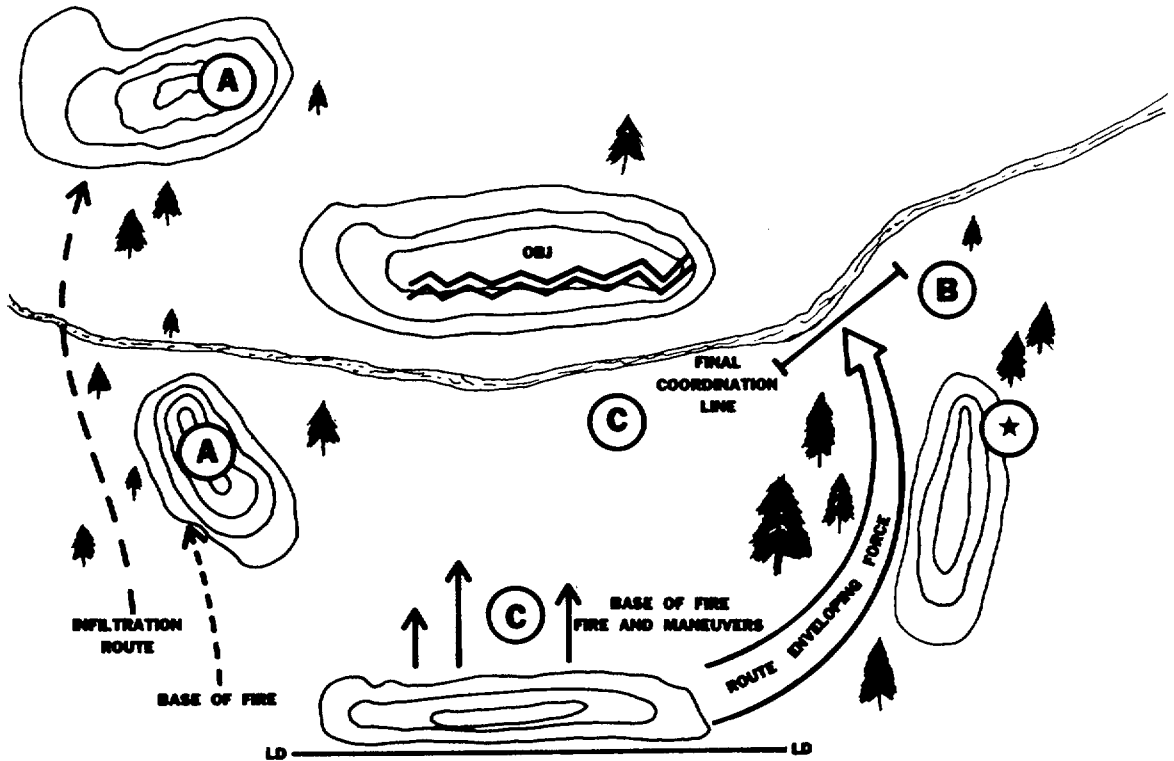

Figure 6-11. Options for Sniper Employment in an Envelopment.

- Snipers move into position, prior to the assault, along the same ground to be covered by the enveloping force, marking the route if necessary, and providing security near the tentative final coordination line. At the moment of decision, they take out selected targets on the objective or on those forces threatening the advance; e.g., ambushes, enemy outposts, demolitions, and boobytraps (point B). They can also be used to protect the flanks of the enveloping force from ambush and surprise (point ★).
- The snipers move into a position between the line of departure and the objective and provide precision fire on the objective, while the base of fire fires and moves toward the objective to deceive the enemy as to the true nature of the assault as the enveloping force closes in on its final coordination line. The whole operation is timed so that the base of fire does not remain under fire too long before the commencement of the real assault (point C).

The sniper teams provide reconnaissance of infiltration lanes, select routes, and maintain security and observation of infiltration lanes and rendezvous points.

INFILTRATION

Snipers are best used outside the scope of normal flank security. They dominate key terrain; cover avenues of approach; confuse the enemy; provide detailed intelligence information on the terrain, route, and enemy; and control fire support.

TACTICAL COLUMNS

When operating with the REAR GUARD, the snipers move behind and to the flanks to delay the enemy and prevent a surprise attack on the main body. The snipers set up blocking positions on key terrain and avenues of approach into the rear of the column. When moving between blocking positions, they move carefully and at their own pace.

When operating with the MAIN BODY, the snipers move out prior to the intended movement and occupy blocking positions (on key terrain) that will be to the "flanks" of normal flank security activities from the main body. In other words, they set up a protective "slot" in a preplanned area for the column to move through. As the column reaches the snipers' blocking position, the snipers fall in with the rear guard and operate with the rear guard until the column stops again. At that time, the snipers can move out ahead of the column and set up another set of blocking positions to form another protective "slot".

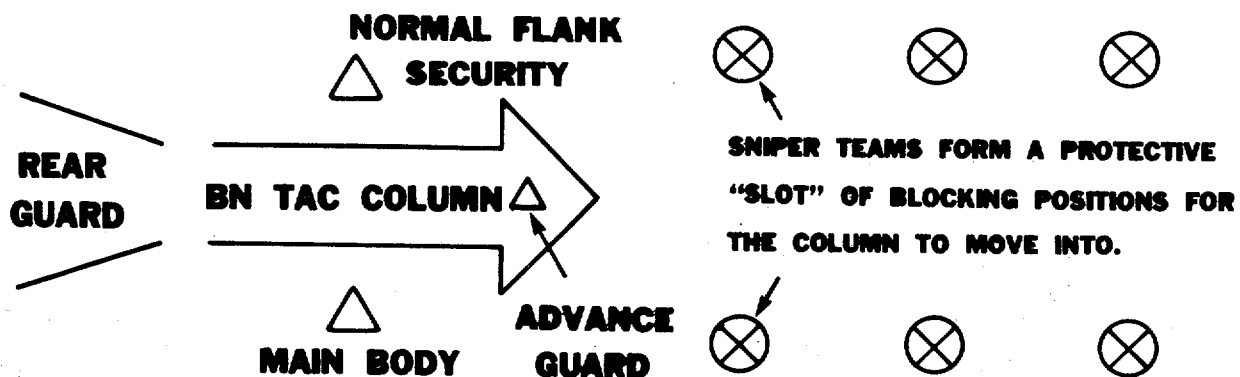

Figure 6-12. Sniper Employment Option (Slot of Blocking Positions).

When operating with the *advance guard*, the sniper teams again move out well before the planned movement, recon the route, and set up blocking positions well forward of the movement to observe and report information and to prevent surprise from the front. As the column catches up, the snipers fall in with the advance guard and operate with them until the column stops, at which time they can move out again ahead of the column.

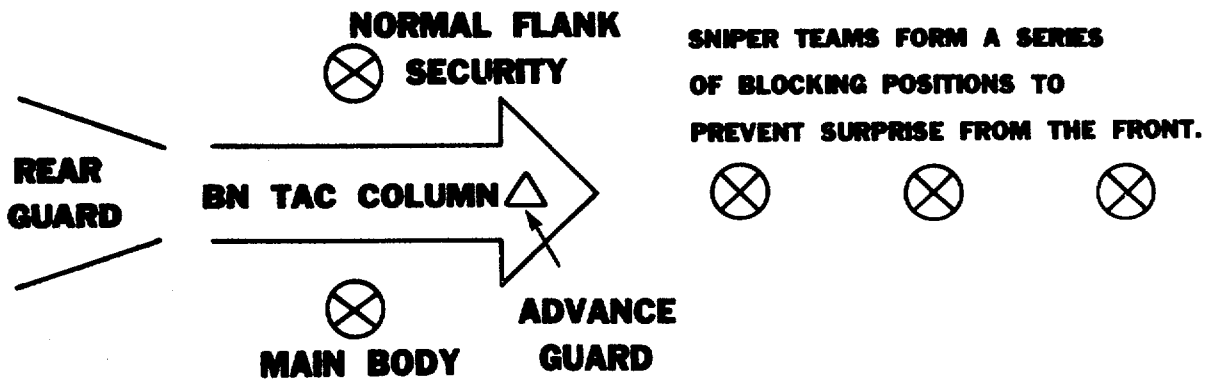

Figure 6-13. Sniper Employment Option (Series of Blocking Positions).

It should be emphasized that the sniper teams should move out prior to the projected movement so they can move at their own pace to facilitate undetected movement. The sniper teams are operating *outside* the scope of normal infantry flank security and the blocking positions should be established *well* forward of the column in the most dangerous parts of the route. Snipers, supporting *mounted infantry movements* operate in the same manner, however, it should be emphasized that the employment is a one time affair. Again, the snipers move out well ahead of the time of projected movement to set up on the *most dangerous* parts of the route. When the mounted column approaches the sniper protected part of the route, the snipers are picked up by the vehicles in the middle of the column. Mounted snipers are ineffective and cannot be utilized until the column stops, and even then, they have little effectiveness in immediate action or a fire fight. Due to the speed of a mounted column, the snipers cannot be deployed again along the route unless the column stops for an extended period of time.

NIGHT ATTACKS

The snipers go out with the patrol and deploy either near the probable line of deployment or as flank security at the probable line of deployment. Here they collect detailed information on:

- Enemy patrolling activities.
- Outposts.
- Listening posts.
- Enemy defensive positions.

With the aid of their starlight scopes, they report developments near the probable line of deployment and the objective that could have an adverse effect on the mission .

The snipers will preplan fires on enemy positions/concentrations, such as outposts/listening posts, and take out key targets on the objective when the attack goes illuminated or when the attacking force is discovered.

To avoid compromise of the probable line of deployment and the movement into the probable line of deployment by the attacking force, the snipers may have to "silently" remove enemy listening posts near the moment of decision.



Figure 6-14. Sniper Conducting Class.

The sniper can dispose of enemy security elements, that may compromise the probable line of deployment or movement of the main body into the probable line of deployment, by controlling fire support disguised as normal harassment or interdiction fires on the enemy security elements (patrols, outposts, and listening posts).

The probable line of deployment should under no circumstances be located within enemy hearing, observation or local security, and patrolling activities.

The attacking force would benefit by incorporating the sniper's techniques of movement, and slowly "stalk" in toward the enemy once the probable line of deployment is reached. The infantry should also be taught the sniper's techniques of individual camouflage and concealment.

TANK/INFANTRY ATTACKS

The snipers' primary concern is security of the tanks. His primary targets are enemy tank crews and weaponry (sights, tubes, etc.) and enemy tanks (apertures) and crewmen. The enemy tank commanders and drivers would be the sniper's targets as well as the optics. Snipers in position on the flanks prior to the assault can detail enemy tanks and anti-tank personnel/positions (using advanced optical gear and observation techniques) and can reduce these targets prior to or during the assault.



Figure 6-15. Sniper Team in Action.

Primary targets:

- Enemy antitank crews and weaponry.
- Enemy tanks (apertures) and crewmen.

When the infantry is mounted, the manner of sniper employment is much the same. It must be emphasized that the use of snipers in this situation is a one-time affair. As the mechanized force passes through the sniper position, the snipers can continue to reduce selected targets on the objective (due to their pinpoint accuracy). Once the objective is taken, the snipers move to the objective to aid in the consolidation phase.



Figure 6-16. Attack on Enemy Bunker.

Operating independently, the sniper teams participate in the sequence of reduction (blind, burn, and blast) and help ensure that mutually supporting positions are reduced simultaneously. The sniper teams should go ashore with the first wave. With their advanced optical devices and highly skilled observation techniques, the snipers can identify enemy bunkers that could not normally be seen by the untrained eye. They can also tell, by the position of the apertures, which bunkers are mutually supporting to determine the sequence of reduction for the infantry.

Snipers provide accurate, precision fires through the apertures of enemy bunkers. Their optical gear allows them to see into enemy positions.

AMPHIBIOUS ASSAULT ON A FORTIFIED POSITION



Figure 6-17. Sniper Team Firing in Support of Search Party.

Snipers can:

- Protect the flanks.
- Pin down enemy personnel within the bunkers, providing cover for infantry advancing for the "blast" sequence.
- If many positions are mutually supporting and cannot be reduced simultaneously, snipers can help pin down those bunkers that cannot be reduced immediately with the aid of smoke or white phosphorous.

COMBAT IN BUILT-UP AREAS

For extended periods of time, snipers operate from hides set up to dominate and establish "no man's land," screen flanks, protect the rear, and deny the enemy access to certain areas or avenues of approach. The snipers can operate with the covering party (squad) to deliver accurate fires in support of the search party (fire team). Their optical devices again allow them to see into rooms, detect movement, and reduce it instantly.



Figure 6-18. Sniper Team Firing in Support of Street Crossing.

The snipers can also support (by fire) infantry movements across streets. They will provide precision, immediate fire on enemy machinegun nests and enemy snipers hindering the friendly advance. There is no better countersniper weapon than another sniper who knows where to look for possible sniper positions and is capable of immediately reducing the sniper threat.

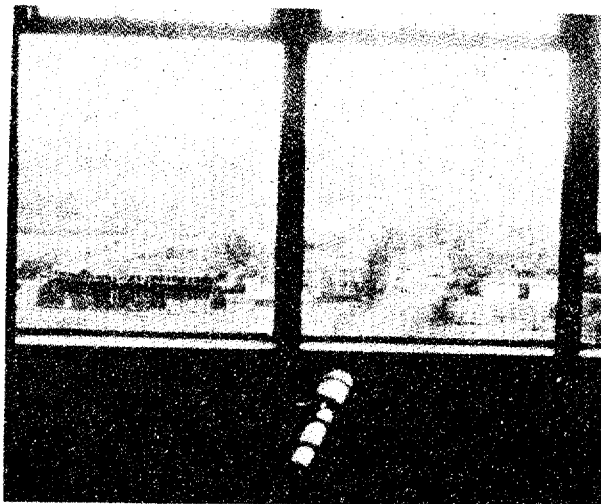

Figure 6-19. Sniper in Urban Hide.

RETROGRADE OPERATIONS

Snipers are assigned missions of supporting the action by:

- Delaying and inflicting casualties upon the advancing enemy.
- Observing.
- Covering (by fire) avenues of approach and obstacles.
- Harrassing the enemy and causing him to deploy prematurely.
- If the situation permits, directing supporting arms fire on large groups of the enemy.

IMMEDIATE ACTION DRILLS

Proper employment of snipers and flank security to help protect the flanks can preclude the likelihood of ever having to deploy a force in immediate action to combat enemy snipers or enemy ambush and detract from the primary mission (which the enemy is trying to do). Snipers should move well ahead of the supported infantry on the flanks, outside the range of normal flank security. Large concentrations of enemy (ambushes) can be discovered by the snipers and reduced by calling in supporting arms fire.

During infantry training, immediate action drills should be conducted at times with the snipers acting as aggressors to test infantry reaction. In the offense, the whole unit should not stop the conduct of the assault for an extended period of time, due to enemy sniper fire. At most, a fire team should be employed with the addition of supporting arms fire. Smoke can be used to screen the main body and allow continuation (by fire and movement) of the offensive (smoke placed between friendlies and enemy fire).

The best countersniper weapon is another SNIPER.

603. DEFENSIVE EMPLOYMENT

The sniper is best used outside of the forward edge of the battle area (FEBA) to provide early warning of enemy approach, disrupt it, and if possible, cause him to deploy prematurely. However, positions should also be prepared by the infantry under the supervision of the snipers, within the defensive perimeter. Primary, alternate (snipers are actually comparable to a crew-served weapon), and supplementary positions should be prepared, when time permits, complete with range cards, to cover the following: avenues of approach, crew-served weapons, tanks, obstacles, deadspace in final protective lines, and dangerous terrain features. Snipers can be used on terrain outside of the FEBA to cover gaps (breaks in continuity that cannot be covered by small arms fire from the FEBA), when a final protective fire from supporting arms fire cannot be used. Positions are not directly on the frontlines but are "within" the FEBA due to the sniper's limited firepower.

LINEAR DEFENSE

When operating with the reserves in a linear defense, snipers cover intervals (breaks in continuity that can be covered by small arms fire) between frontline units, maintain flexibility, man combat outpost positions, man outposts/listening posts, limit penetrations and infiltrations, and cover the flanks and rear.

PERIMETER DEFENSE

In a perimeter defense, the sniper positions within the FEBA should not be located on the topographic crest, so as to protect them from the enemy's supporting arms fire, nor should they be directly on the frontlines.

REVERSE SLOPE DEFENSE

In a reverse slope defense, the snipers are best employed with the security element. They could also possibly be employed with the reserves if the terrain was acceptable.

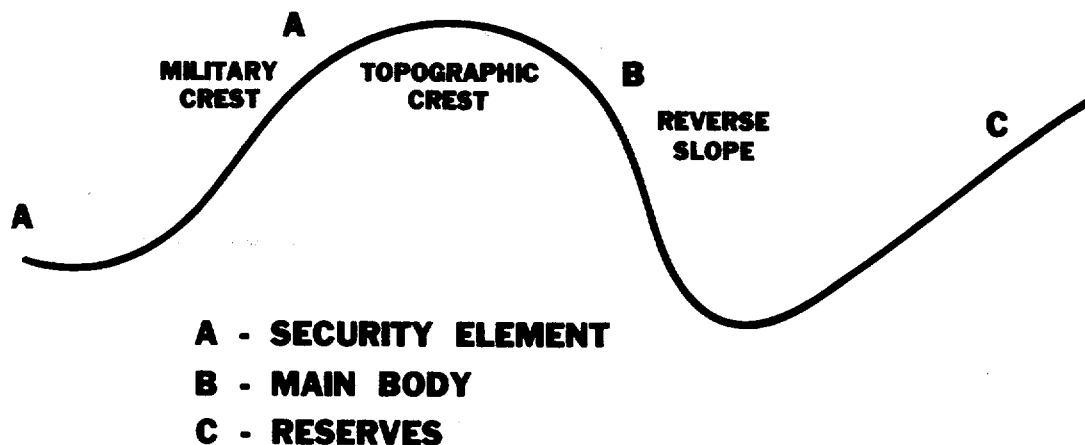

Figure 6-20. Reverse Slope Defense.

In the defense of a riverline, the snipers are employed, initially, with the covering force on the enemy side of the river to maintain contact with the enemy, delay his advance, and determine his assembly areas and possible crossing sites. When forced to retire to the friendly side, the snipers are located far to the friendly flanks to prevent surprise. Naturally, in an *offensive* river-crossing operation, the snipers move into position prior to the crossing to maintain observation and security of the crossing site.

Departure and return are coordinated with frontline units on the FEBA, and if operating in another unit's defensive sector, they make sure they have been included in that unit's defensive order as an inorganic security element operating in their sector (HAS(S); see chapter 7 for a patrol order format).

RIVERLINE DEFENSE

Snipers are best used, in addition to local security, outside the FEBA (flanks, forward, and rear). They move out at night, construct hides on likely avenues of approach, and provide early warning to the FEBA of impending attacks, probes, or infiltrations, and reduce "selected" key targets.

Snipers will provide early warning of night attacks. At the proper time, they take out enemy guides at the probable line of deployment and release points, force the enemy to deploy early or to go illuminated, gather intelligence data on routes/release points, and cause confusion and panic.

Snipers are excellent deterrents for enemy infiltration attempts. The snipers, by covering intervals between units, flanks, and the rear of friendly positions (in areas that cannot be covered with regular patrolling and observation activities from the FEBA), greatly reduce the possibility of surprise. The sniper must put himself in the mind of the enemy, constantly trying to outthink the enemy in planning the location for his hides.

In the defense, the methods in which the snipers are employed are dictated in regards to how far from friendly lines and protection they must operate.

The following instruments of insertion/employment are classified from near to far-reaching activities:

- Inserted as an addition to local security, outposts/listening posts (snipers stalk out from the FEBA).
- Inserted and picked up as an extension of normal patrolling activities from the FEBA (patrols provide security and help in preparation of hides).
- Snipers stalk out and operate forward of a combat outpost as a series of outguards.
- Snipers operate from a patrol base out to the limit of patrolling range.
- For far-reaching missions, snipers are *deep-inserted* by helicopter (no friendly protection), or operate as part of a raid force.

The snipers must be provided with a certain degree of infantry protection to their rear, which is the snipers most vulnerable area, especially when they are in a hide. This security is not close enough to compromise the position but near enough to help in the extraction if necessary (within 1,000 meters).

PATROLLING

Snipers help the infantry commander maintain his offensive posture while in the defense. Snipers go out with, operate as an extension of, and return with normal patrolling activities. They can also be used in lieu of certain patrolling activities.

The snipers number one use in patrolling is as an extension of a *SECURITY PATROL*.

The security patrol provides protection and help in building the hide and then continues with the rest of their patrol, leaving the snipers behind. So in a sense, you now have two groups fulfilling the function of a security patrol.

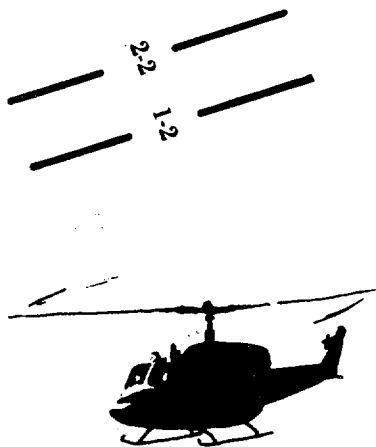

The snipers:

- Prevent enemy infiltration.
- Detect and destroy infiltrators.
- Protect the FEBA from surprise attack.
- Protect friendly patrols from ambush.
- Screen the flanks and rear of the defensive position.

Snipers can also operate as an extension of *contact patrols* (to help establish contact with an enemy force whose definite location is not known) or *search and attack patrols* (with a combined mission of reconnaissance and combat). Snipers can actually operate "as part of" an *ambush patrol* or *reconnaissance patrol*.

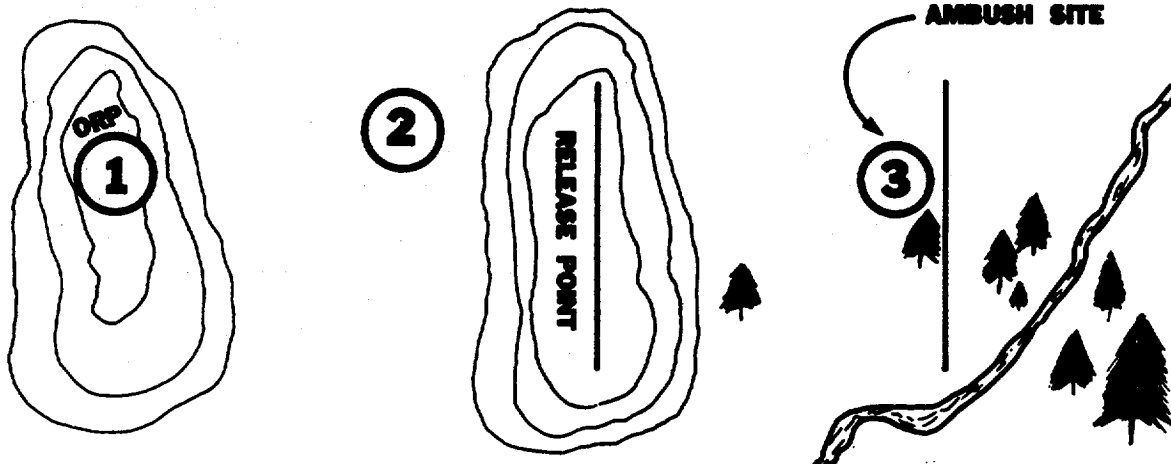

Figure 6-21. Ambush.

As part of an ambush patrol, the sniper can be used to secure the objective rallying point, or move into a position between the objective rallying point and the release point to cover the withdrawal by delaying and harassing enemy pursuit, or they can be used at the ambush site only if there is a need to reduce a specific target.

AMBUSH PATROL

As part of a reconnaissance patrol the snipers are used either as part of the security team or the reconnaissance team. They can also be used to provide objective rallying point security or rendezvous point security.

RECONNAISSANCE PATROL

COMBAT OUTPOST

Snipers are employed as a series of outguards, as a counter-reconnaissance screen to provide early warning of enemy approach, and to gather detailed information on the enemy. The snipers deny the enemy close observation of the battle area. They delay and confuse the enemy in hopes of making him deploy his forces prematurely. The snipers deceive the enemy as to the true location of the battle area. The snipers can also be used to cover the rear when the outguards withdraw to the FEBA. The sniper's observation skills and fire support control are definite assets to be utilized when establishing a combat outpost. He can do much to keep the enemy off balance by making only a few kills in one location and keeping constantly on the move to the next position.

PATROL BASES

When there is a need for more distant sniping operations, the sniper teams establish a platoon patrol base in conjunction with an infantry unit (platoon). The sniper teams operate from the platoon patrol base, and the normal infantry patrolling activities from the platoon patrol base provide the necessary backup for the snipers and help in construction of the hides. The snipers establish their positions within normal patrolling range of the platoon patrol base.

RAIDS

Snipers are used with the security forces to isolate the objective, cover avenues of approach into the objective, cover the routes of friendly withdrawal, prevent enemy reinforcement, and assist in the observation of the objective and surrounding areas. The snipers can be used with the support element if a specific enemy target is to be eliminated.

DEEP INSERTIONS

The teams can be inserted, at night, by low level treetop-high insertion by helicopter. The snipers can rappel if need be. The helicopters should fool the enemy as to the true location of the insertion by conducting "touch and goes" or by hovering over multiple locations prior to and after the actual insertion. The sniper teams would be supplied with "spic rigs" for rapid immediate extraction by helicopter if necessary. Immediate extraction would be covered by fire support or helicopter-gunship support controlled by the sniper. Normal extraction would be accomplished by helicopter.

If operating from a hide, constructed and camouflaged properly, the snipers would be able to stay in the hide until the enemy force moved through them. Immediate extraction would not always be necessary. As there is no immediate friendly backup available, a deep insertion of snipers should only be undertaken if a specific enemy target is to be eliminated.

When employed behind enemy lines, the sniper harasses and demoralizes the enemy, causing him to redeploy some of his frontline troops to protect important supply depots, commanders, and installations in rear areas. This will effect the enemy's feeling of "security" even in their own territory.

SUMMARY

A smart commander makes maximum use of all his assets in a fight. All infantry commanders must be strongly versed in the employment of snipers and employ them effectively and correctly in all forms of tactical training. The classical sniper definitely has an application on the modern battlefield, and if utilized correctly will greatly contribute to our quest of winning the first battle of the next war.



IN MOST CASES, THE MEANS OF SNIPER EMPLOYMENT SHOULD NOT BE PLANNED ON A LEVEL LOWER THAN THE COMPANY COMMANDER'S LEVEL, AND SNIPER TEAMS SHOULD NOT BE ATTACHED OUT LOWER THAN THE COMPANY LEVEL.



SECTION 7

PLANNING AND PREPARATION OF A SNIPER MISSION

701. INTRODUCTION

All aspects of planning and preparation of a sniper mission are contained in this section, from the sniper employment officer's responsibilities to the sniper team's responsibilities in planning, preparing, and executing a mission. A sniper patrol is always "tailored" for the mission it is to execute.

A sniper mission (patrol) is a detachment of one or more sniper teams performing an assigned mission of engaging selected targets and targets of opportunity, and collecting and reporting information, or a combination of these, which contribute to the accomplishment of the supported infantry's mission.

DEFINITION

702. SNIPER EMPLOYMENT OFFICER

The responsibilities of the sniper employment officer/staff noncommissioned officer (SNCO) in the planning and preparation of a sniper mission are:

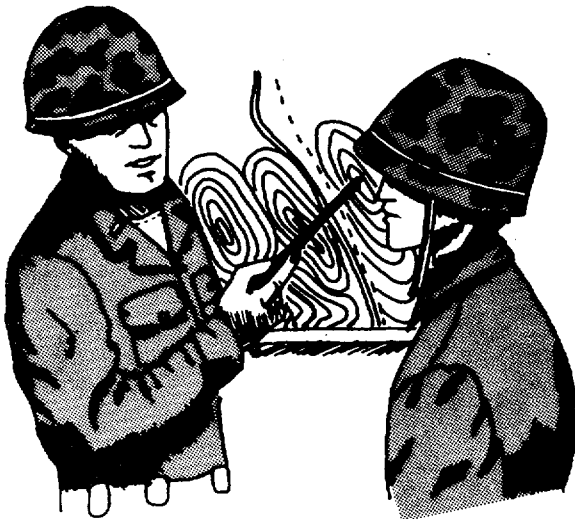

Figure 7-1. Sniper Employment Officer.

- Issuance of necessary orders to the sniper team leader.
- Coordination.
- Assignment of patrol missions and type of employment.
- Supervision.
- Briefing team leaders.
- Debriefing team leaders.
- * ● Advising the supported unit commander on the best means to employ and utilize his sniper teams.
- * The most important responsibility.

The sniper employment officer/SNCO is directly responsible to the battalion commander for the operational efficiency of his sniper teams. He must also work hand-in-hand with the S-2 and S-3 officers.

ISSUANCE OF NECESSARY ORDERS TO THE SNIPER TEAM LEADERS

If the sniper employment officer/SNCO is not available, such as when sniper teams are attached out to the company level, the sniper team leader assumes the sniper employment officer's/SNCO's responsibilities.

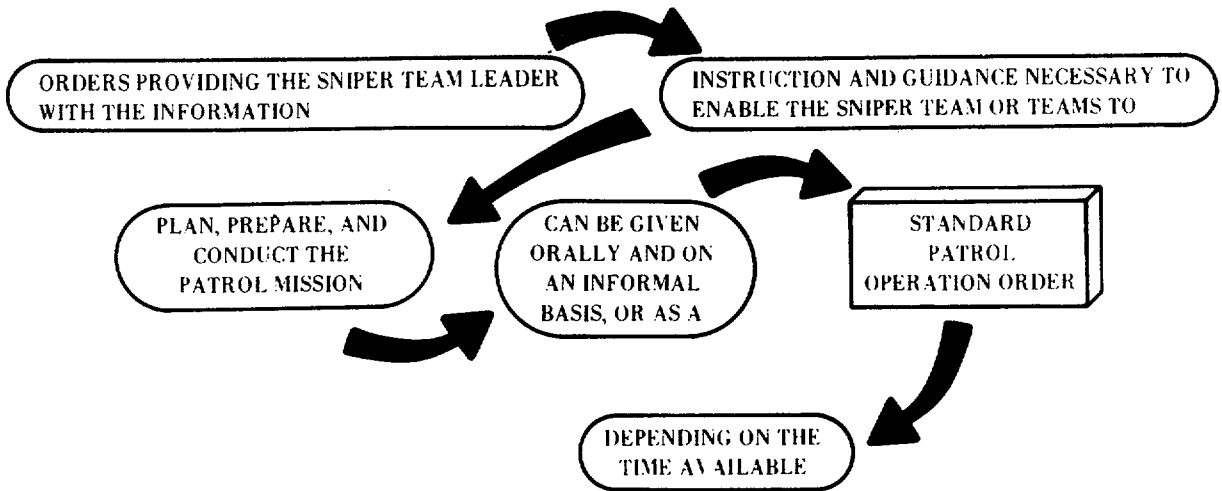

The responsibility for all detailed planning, when practical, should be given to the sniper team leader. The mission should be described in only the most general terms by the sniper employment officer or the supported infantry commander. The routes, targets, location of firing positions, detailed mission planning, fire support planning, and coordination should be the responsibility of the sniper team leader. When he has time, he should prepare and issue, to the observer, a detailed patrol order to ensure that he has planned for every contingency.

COORDINATION

Coordination is a continuing, joint effort by the sniper employment officer/SNCO and the sniper teams. The three general areas of coordination are between the:

- Staff and staff of other units.
- Staff and the sniper team leaders.
- Sniper team leaders and units immediately affected by the patrol's operation.



Figure 7-2. Sniper Briefing Infantry Commander.

Recommendations for sniper missions to be conducted and the sniper teams to be provided are submitted to the commander for his approval.

The commander may, in his briefing to his staff, inform the sniper employment officer or sniper team leader that snipers may be needed in the overall "big picture."

A sniper patrol is assigned only ONE major mission. The essential tasks required to accomplish the mission are assigned to both the sniper teams and elements of the supporting units (backup units).

Whether the sniper mission be a specific mission or a general mission, it must be clearly stated, thoroughly understood, and within the CAPABILITIES of the sniper team.

ASSIGNMENTS OF PATROL MISSIONS AND TYPE OF EMPLOYMENT



Figure 7-3. Staff Noncommissioned Officer Supervising Sniper Team.

SUPERVISION

Supervision is provided by the sniper employment officer/SNCO in planning, preparation, and rehearsals, giving the sniper team leaders the benefit of their own training and experience.

BRIEFING TEAM LEADERS

Once the commander has stated the need for snipers, the sniper employment officer, if available, must brief the sniper team(s) on the assigned mission.



Figure 7-4. Sniper Team Briefing.

DEBRIEFING SNIPER TEAM LEADER

On return, sniper teams are debriefed by the sniper employment officer/SNCO and by the S-2 and S-3 representatives, or the supported infantry commanders. The patrol report form is used to help ensure complete debriefing.

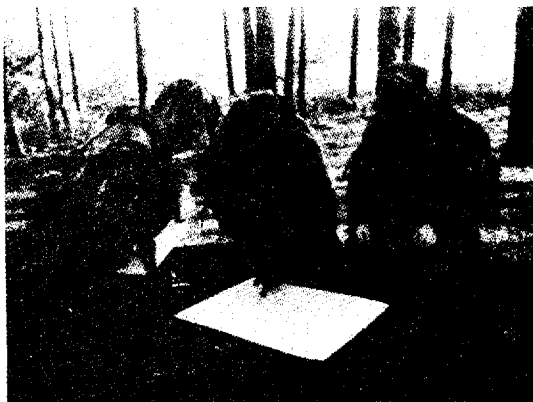

Figure 7-5. Debriefing.

**P
A
T
R
O
L

R
E
P
O
R
T**

(DESIGNATION OF PATROL)

TO:

MAPS:

- A. SIZE AND COMPOSITION OF PATROL
- B. TASK (MISSION)
- C. TIME OF DEPARTURE
- D. TIME OF RETURN
- E. ROUTES (OUT AND BACK)
- F. TERRAIN (COMPLETE DESCRIPTION)
- G. ENEMY

STRENGTH, DISPOSITION, CONDITION OF DEFENSE, EQUIPMENT, WEAPONS ATTITUDE, MORALE, EXACT LOCATION, MOVEMENTS, AND ANY SHIFTS IN DISPOSITION, TIME ACTIVITY WAS OBSERVED, COORDINATES WHERE ACTIVITY OCCURRED

- H. MAP CORRECTIONS
- J. MISCELLANEOUS INFORMATION
- K. RESULTS OF ENEMY ENCOUNTERS (KILLS)
- L. CONDITION OF PATROL, INCLUDING DISPOSITION OF ANY DEAD OR WOUNDED
- M. CONCLUSIONS AND RECOMMENDATIONS

SIGNATURE/GRADE/RANK/ORGANIZATION/UNIT

(FILLED OUT UPON COMPLETION OF EVERY MISSION)

RECEIVING THE ORDER

During the issuance of the order (briefing by the sniper employment officer/SNCO, battalion commander, or supported company commander), the sniper team leader listens carefully to ensure that he clearly understands all information, instructions, and guidance. He takes notes (or uses a checklist) for later use in planning. After the briefing, he asks questions if points are not understood or not covered.

If supporting an infantry commander, it is the sniper team leader's responsibility to advise the commander of the proper and optional means of sniper employment to best accomplish the mission.

703. PATROL STEPS

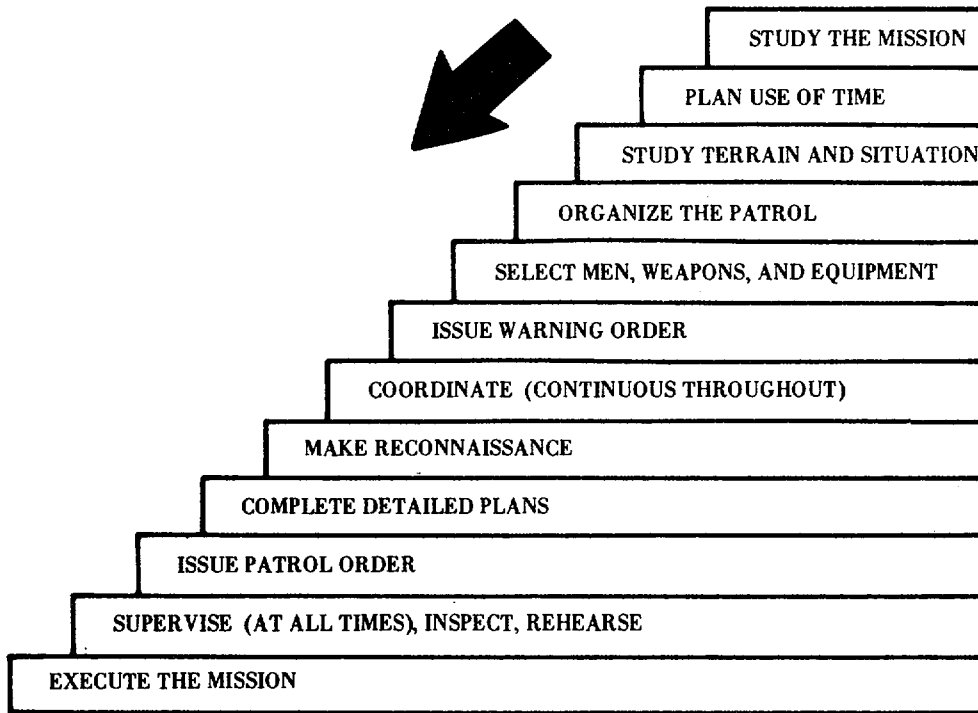

ESTIMATE OF THE SITUATION

In the preparation of his detailed order, the estimate of the situation is reflexive and continuous by the team leader, upon receipt of his order.

- M ission
- E nemy
- T errain and weather
- T roops and fire support available

STUDY THE MISSION

The sniper team leader carefully studies the mission. Through this, and the study of the terrain and situation, he identifies the essential tasks to be accomplished in executing the mission.

Example. Mission: Need sniper security for day ambush, site grid 87659387.

The blocking of routes of escape from the kill zone is an essential task which must be accomplished to execute the mission.



Figure 7-6. Situational Studies.

PLAN USE OF TIME

Combat situations seldom allow the sniper team leader as much time for planning and preparation as he would like. A well-planned sniper patrol should be planned 24 to 48 hours prior to the time of departure. The sniper team leader should plan his time schedule around specific times (i.e., time of departure, time of attack, etc.) in the operation order.

STUDY AND ANALYZE THE TERRAIN AND SITUATION

Terrain. The sniper team leader and his team study the terrain over which they will be moving, the friendly and enemy situations, and areas of operation.

The sniper team makes a detailed study of maps and aerial photographs (if available) and, if time allows, makes a sand-table or terrain model of the terrain over which they must pass, to aid in position and route selection. It must include the objective area.

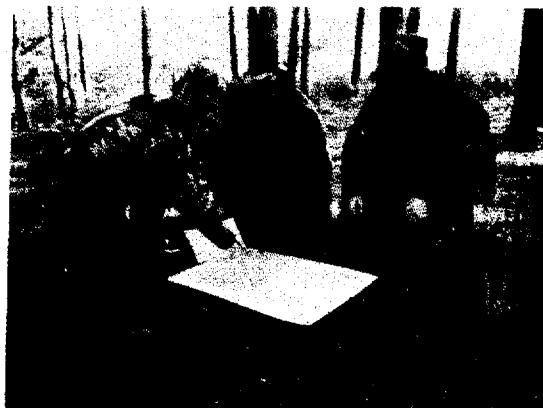

Figure 7-7. Studying Maps and Aerial Photographs.

Situation. The sniper team leader studies the strengths, locations, dispositions, and capabilities of the friendly forces and their fire support that may affect the mission's operation.

The sniper team leader should put himself in the mind of the enemy and come up with an educated guess as to where the enemy is likely to be and what he is likely to do before and after the long-range, precision sniper shot. He should ask himself questions about the enemy:

- What has the enemy done in the past?
- What is he likely to do NOW?
- How will the enemy be moving (security activities; patrols, platoons, or companies; etc.)?
- What will the enemy be trying to accomplish?
- What avenues of approach will be utilized?
- How will terrain and weather affect his movement?
- When will the enemy move?
- What is his plan/tactics?
- How can the sniper's rifle and fire support plan combat likely and known enemy activities and contribute to the accomplishment of the friendly infantry mission?

The sniper team leader makes his tentative plan of action. The plan may include:

- Type of position.
- Location of position.
- Type employment.
- Security backup needs (fire team, squad, etc.).
- Target location.
- Passwords of frontline infantry units.
- Time of departure and return.
- Equipment needed.
- Route selection.
- Communications.
- Call signs and frequencies needed.
- Fire support available.

A tentative plan is later developed into a detailed plan of action.

ORGANIZE THE PATROL AND INFANTRY BACKUP TEAM AND SELECT WEAPONS AND EQUIPMENT

MAKE A TENTATIVE PLAN

If the sniper team is to be inserted as an extension of patrolling activities (by a security patrol), the security patrol leader maintains operational and logistic control over the sniper team until the sniper team is dropped off, and then resumes control when the snipers are picked up on the return of the patrol. (The sniper team leader coordinates with the patrol

leader/backup team on the special equipment necessary for the infantry members of the patrol, such as axes, picks, sandbags, ponchos, precut logs, etc., for hide construction, as it may be necessary for the infantry members to help in the preparation of a hide.) If the snipers should require immediate aid and extraction, the patrol leader/infantry backup team commander and the sniper team leader also coordinate the concept and plan of backup, the normal pickup procedures, and the times, if applicable. Both the sniper team leader and the patrol leader/backup team commander must be thoroughly familiar with each other's missions, routes, and fire support plans. The patrol/backup leader must be able to terminate his patrol mission at any time in order to help extract the sniper team, if necessary. The two leaders must coordinate time schedules as well (i.e., time of rehearsals, time to issue patrol order, time of departure, etc.).

It is the responsibility of the sniper team leader to coordinate with all friendly units. Examples of coordination which must be made are:

- Movement in friendly areas. Commanders must be informed of where and when the sniper team will be operating in their sector. Sniper teams must also have information on other friendly activities (patrols) in the area of operations.
- Departure and reentry of friendly areas (passwords). Detailed coordination is required here.
- Fire support plan and other friendly fires planned in the sniper's area of operations.
- Movement of other sniper teams.

A reconnaissance may be limited to just a detailed map and/or aerial photograph, or from the point of departure to the limit of sight. Briefings by units who have previously operated in the area will also be of help.

The sniper team leader ensures that nothing is left out from the predeparture of friendly lines to reentry of friendly lines.

The way an order is issued is the way it will be received and understood. The order is issued confidently and in a loud and clear voice, continually referring to a detailed sandtable or rough terrain sketch.

COORDINATE

MAKE A RECONNAISSANCE

COMPLETE DETAILED PLAN

ISSUE PATROL ORDER

SUPERVISE

The sniper leader inspects his team and rehearses them.

REHEARSE

Visual aids, such as terrain models, blackboards, and sandtables, are used to help ensure COMPLETE understanding by all personnel. If visual aids are not available, planned actions are sketched out on paper, sand, dirt, or snow.



Figure 7-8. Rehearsal.

An effective method for rehearsal is for the sniper team leader, team members, sniper employment officer/SNCO, or supported infantry commanders concerned with the mission to talk the entire patrol through each phase of the mission, describing the actions to take place from the time of departure to return. Terrain models should be used in this method of rehearsal.

The key to effective execution is detailed planning to cover every contingency during the previous patrol steps. "What can go wrong, will go wrong." The only defense is detailed planning and never letting his guard down. The sniper is always thinking, putting himself in the mind of the enemy, asking himself what would he do if he were in the enemy's shoes.

EXECUTE THE MISSION

704. WARNING ORDER

The time needed to prepare for a mission depends on such factors as the nature of the mission, the proficiency of the sniper teams, the time allowed for reconnaissance, etc. The sniper team leader provides maximum preparation time possible by issuing a warning order. If an infantry backup force is to be utilized, the sniper team leader will coordinate and issue his warning order in conjunction with the patrol/backup leader.

The patrol warning order consists of the following:

PATROL WARNING ORDER

- A. A brief statement of the situation.
- B. Mission of the patrol.
- C. General Instructions:
 - 1. General and special organization of patrol (if operating with an infantry patrol/backup force).
 - 2. Uniform and equipment common for all.
 - 3. Weapons, ammunition, and equipment.
 - 4. Chain of command.
 - 5. A time schedule for the patrol's guidance.
 - 6. Time, place, uniform, and equipment for receiving the patrol leader's order.
 - 7. Times and places for inspections and rehearsals.
- D. Specific Instructions:
 - 1. To subordinate leaders.
 - 2. To special purpose teams or key individuals (backup team if applicable).

DISCUSSION OF WARNING ORDER

Situation. Minimum details are given to include only the information the team needs to prepare for the mission. The complete situation is given in the team leader's patrol order.

Mission. This is a brief but clear statement of what the sniper teams are to accomplish and the location or area in which it is to be accomplished.

General Instructions:

Weapons, Ammunition, and Equipment. This paragraph should include the special equipment to be carried by the infantry (if applicable) for the preparation of hides.

Chain of Command. The two-man sniper team is the basic operational organization for the employment of a sniper patrol. The sniper team leader is in charge of his team. The security teams (if needed) will have a chain of command set up by the NCO of the security team or the patrol leader, depending on the situation.

Time, Place, Uniform, and Equipment for Receiving Patrol Leader's Order. If operating with a backup force (patrol) as an extension of patrolling activities, the snipers will also attend the patrol order briefing of the infantry unit conducting the patrol.

Times and Places for Inspections and Rehearsals. Snipers will rehearse with the infantry patrol/backup force if operating as an extension of patrolling activities from the forward edge of the battle area (FEBA).

Specific Instructions. Specific instructions are given to:

Security teams (as pertains to hide preparation and extraction).

705. PATROL ORDER

The patrol order is issued in a standard five-paragraph operation order sequence as shown below. A detailed orientation should be given first from a sandtable.

SITUATION

(AS IT AFFECTS THE PATROL)

- A. Enemy Forces. Weather, terrain, identification, location, activity, and strength.
- B. Friendly Forces. Mission of next higher unit, location and planned actions of units on right and left, fire support available for patrol and mission and routes of other patrols.
- C. Attachments and Detachments.

MISSION

What the patrol is to accomplish and the location or area in which it is going to be done.

EXECUTION

- A. Concept of Operation. The overall plan and mission of elements, teams, and key individuals in the objective area (to include hide construction).
- B. Other missions, not in the objective area, of elements, teams, and individuals; included are such tasks as navigation, security during movement, and security during halts.

- C. Coordinating Instructions:
1. Times of departure and return.
 2. Primary and alternate routes.
 3. Departure and reentry of friendly lines.
 4. Organization for movement.
 5. Actions at danger areas.
 6. Actions on enemy contact.
 7. Rallying points and actions at rallying points.
 8. Actions at objective areas.
 9. Debriefing.
 10. Other actions.
 11. Rehearsals and inspections.

ADMINISTRATION AND LOGISTICS

(The "what" was covered in the warning order, now here in the patrol order, the "how" and "when" are covered.)

- A. Rations (when to eat).
- B. Arms and ammunitions (how to carry).
- C. Uniforms and equipment (how to rig).
- D. Method of handling wounded and prisoners.

COMMAND AND SIGNAL

- A. Command
 1. Chain of command.
- B. Signal
 1. Signals to be used within the patrol.
 2. Communications with higher headquarters, radio call signs, primary and alternate frequencies, times to report, and special code to be used.
 3. Challenge and passwords (to reenter friendly lines).

706. ARM-AND-HAND SIGNALS

Employment of sniper teams in support of infantry units requires the sniper to be thoroughly familiar with arm-and-hand signals used by the infantry. The team's members must thoroughly understand the methods of silent communications that will be utilized during the mission. ANY SIGNAL THAT IS UNDERSTOOD IS CORRECT. Any properly given arm-and-hand signal is considered an order or command to be obeyed INSTANTLY. All standard arm-and-hand signals are listed in FMFM 6-5, *Marine Rifle Squad*.

707. BASIC FIRE SUPPORT PLANNING AND CONTROL

Only the basics of fire support planning and control are covered in this paragraph. Further details can be found in FMFM 7-1, *Fire Support Coordination*; FMFM 7-4, *Field Artillery Support*; FM 23-91, *Mortar Gunnery*; FM 6-40, *Field Artillery Cannon Gunnery*; and FM 6-40-5, *Modern Battlefield Cannon Gunnery*.



Figure 7-9. Arm-and-Hand Signals.

FIRE PLAN SKETCH (OVERLAY)

The sniper team leader should submit a fire support plan sketch for approval to the sniper employment officer or the supported infantry commander for preplanned 81mm mortar and artillery fires to support the sniper mission. These fires are assigned a target number and become "on call" targets.

The fire support plan should show primary and alternate routes, checkpoints, objective rallying point, and the tentative final firing position.

Fires should be planned in several categories:

- Deceptive fires to conceal movement noise and to confuse the enemy.
- Firing along route (possibly on checkpoints) to eliminate enemy from the route. A specific pattern of firing should not be planned, such as firing on checkpoint 1, checkpoint 2, checkpoint 3, etc.
- Firing on possible enemy locations (key terrain, etc.).
- Fires planned to cover withdrawal or extraction.

SNIPERS SHOULD CLOSELY ADHERE TO THE PLANNED ROUTES (THUS, THE NECESSITY OF DETAILED PLANNING AND TERRAIN ANALYSIS) TO PRECLUDE RUNNING INTO OTHER FRIENDLY UNITS OR FIRES.

FIRE SUPPORT CONTROL

Only basic, initial calls for fire are covered, enough to allow the snipers to get that first round or rounds out. For more detailed information on subsequent corrections and control of fire support, see FM 6-40 and FM 6-40-5.



Figure 7-10. Sniper With Radio.

ALL SNIPERS MUST BE EXPERTS IN THE CONTROL AND PLANNING OF ALL TYPES OF FIRE SUPPORT

FIRE SUPPORT PLAN SKETCH IN OVERLAY FORMAT

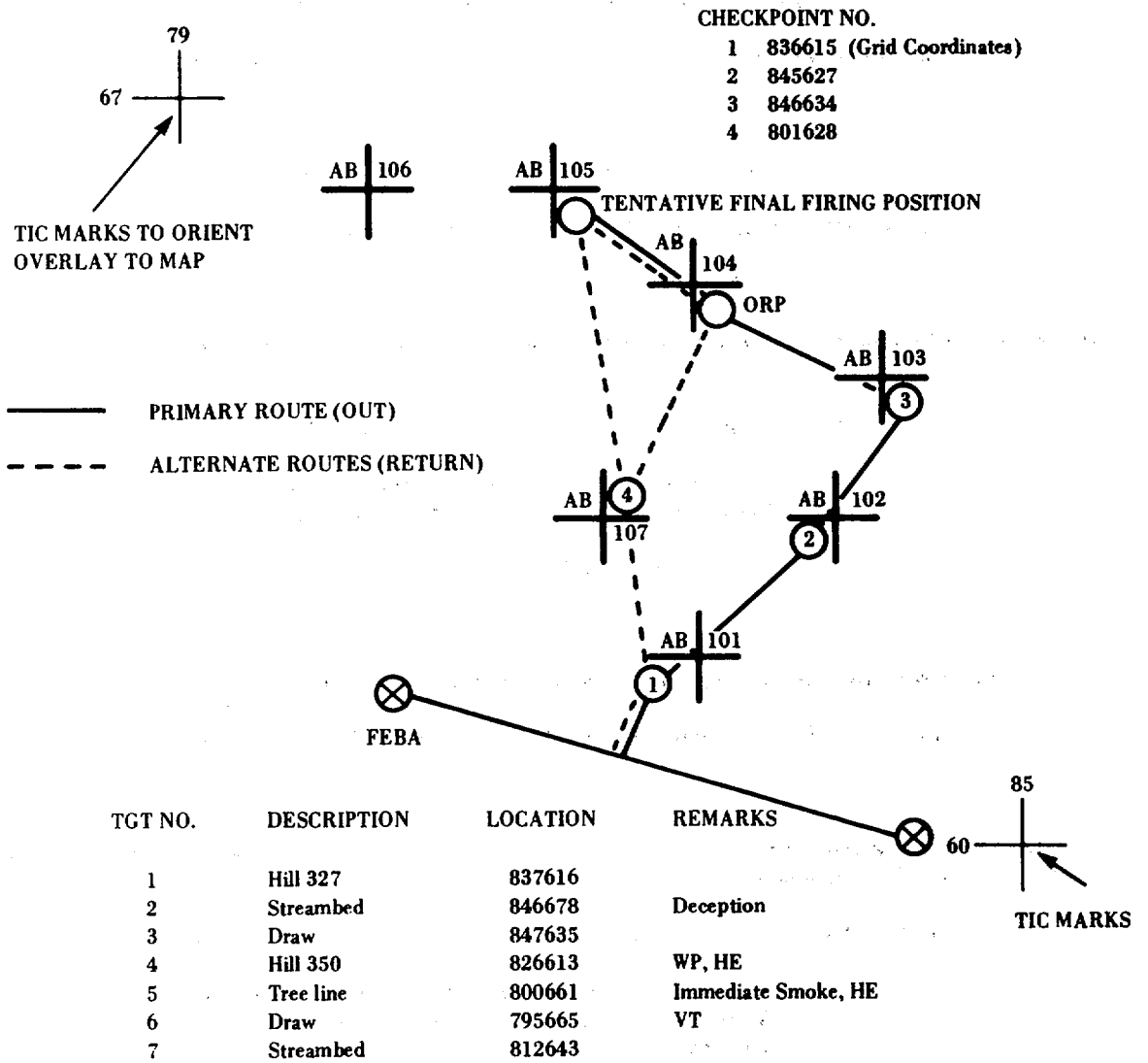

NAME:
 PATROL UNIT:
 DATE TO BE FIRED:
 MAP SHEET & SERIES NUMBER:
 FREQUENCIES & CALL SIGNS OF PATROL:
 TIME OF DEPARTURE:
 TIME OF RETURN:

Figure 7-11. Fire Plan Sketch.

If the target is an "on call" target already planned for and assigned a target number on the fire plan sketch, the call for fire consists of the following:

H-24, THIS IS H-18, SUPPRESS AB101, OVER

(Call Sign of Fire Direction Center (FDC)) (Call Sign of Sniper) (Target Number)

If the target is in an "on call" status and has taken the sniper under fire, the call for fire consists of the following:

H-24, THIS IS H-18, IMMEDIATE SUPPRESSION AB101, OVER

If a target of opportunity presents itself, the grid coordinate method of target location is the easiest. The call for fire consists of the following:

H-24, THIS IS H-18, FIRE FOR EFFECT, OVER

The fire direction center will then read back the call for fire; the sniper transmits the grid coordinates of the target.

GRID 180513, OVER

If a target not in an "on call" status takes the snipers under fire, the grid mission is transmitted as follows:

H-24, THIS IS H-18, IMMEDIATE SUPPRESSION, GRID 18Q513, OVER

Smoke is termed the "thinking man's ammunition" and can be placed between the sniper and the advancing enemy to conceal the sniper's withdrawal. The call for fire is as follows:

H-24, THIS IS H-18, IMMEDIATE SMOKE, GRID 180513, OVER

For Artillery: Immediate smoke missions are fired with a mix of WP and HC for quick buildup, so the sniper should be careful in planning the grid location of the target area. Smoke can be PRE-PLANNED as well.

To REPEAT fires (when the sniper desires more rounds in the same location specified in the call for fire), the sniper says:

H-24, THIS IS H-18, REPEAT, OVER

708. ZONE BRIEFS

The sniper team leader must plan for immediate extraction, should it become necessary. This should be preplanned, when possible, to be picked up at a specific checkpoint or the objective rallying point (ORP). *When in trouble, the snipers should call for fire, possibly smoke, and withdraw along a preplanned route to a pickup zone where they can be picked up by helicopter.* If unable to withdraw, the sniper can be picked up by "spie rig," again under the cover of sniper planned fire support.

If the hide is properly constructed, the possibility of needing an immediate extraction is greatly reduced, as the enemy will not be able to see it even while standing on top of the hide.

If an infantry backup force is employed, they can aid in extracting the sniper team.

When giving a zone brief, the sniper must talk clearly, quickly, and accurately.

Snipers MUST know the frequency and call sign of the helicopters.

HELICOPTER ZONE BRIEF

- Identification (call signs) (immediate extraction).
- Description of landing zone (size, shape, secure, or insecure).
- Ground obstacles in and around landing zone.
- Wind direction and velocity.
- Obstacles in approach path.
- Time/direction of last enemy fire.
- Suspected enemy positions/heavy caliber weapons.
- Direction from which enemy fire is most likely.
- Approach direction for helicopter (land helicopter into the wind).
- Direction cleared to return fire.
- MEDICAL EVACUATION ONLY: Number, precedence, and type wounded.
- Landing zone marking (mark with smoke, make pilot identify color).

TALK THE PILOT INTO THE SNIPER POSITION USING THE CLOCK SYSTEM—THE DIRECTION HIS NOSE IS POINTING IS 12 O'CLOCK

SPECIFY THE NEED TO BE PICKED UP BY SPIE RIG IF THE TEAM AND HELICOPTERS HAVE THE CAPABILITY AND IF THE SNIPERS ARE STILL UNDER HEAVY FIRE

APPENDIX A

RANGE ESTIMATION TABLES

TABLE OF MILS FOR PERSONNEL
6 FEET, 5 FEET 9 INCHES, AND 5 FEET 6 INCHES

<u>MILS</u>	<u>6 FEET = 2 YARDS</u>	<u>5 FEET 9 INCHES = 1.9 YARDS</u>	<u>5 FEET 6 INCHES = 1.8 YARDS</u>
1	2000	1900	1800
1-1/4	1600	1520	1440
1-1/2	1333	1266	1200
1-3/4	1143	1085	1028
2	1000	950	900
2-1/4	888	844	800
2-1/2	800	760	750
2-3/4	727	690	654
3	666	633	600
3-1/4	615	584	553
3-1/2	571	542	514
3-3/4	533	506	480
4	500	475	450
4-1/4	470	447	423
4-1/2	444	422	400
4-3/4	421	400	378
5	400	380	360
5-1/4	380	361	342
5-1/2	362	345	327
5-3/4	347	330	313
6	334	316	300
6-1/4	320	304	288
6-1/2	308	292	277
6-3/4	296	281	266
7	286	271	257
8	250	237	225
9	222	211	200
10	200	190	180

TABLE OF MILS FOR OBJECTS

FEET		3	4	5	6	7	8	9	10	11	12	13	14	15	16	17	18		
YARDS		1	1.3	1.7	2	2.3	2.7	3	3.3	3.7	4	4.3	4.7	5	5.3	5.7	6		
MILS	2	500	650	850	1000	1150	1350	1500	1650	1850	2000	2150	2350	2500	2650	2850	3000		
	2.5	400	520	680	800	920	1080	1200	1320	1480	1600	1720	1880	2000	2120	2280	2400		
	3	333	425	566	665	766	900	999	1100	1230	1332	1433	1566	1665	1766	1900	1998		
	3.5	285	371	486	571	657	771	855	943	1057	1140	1229	1343	1425	1514	1629	1710		
	4	250	325	425	500	575	675	750	825	925	1000	1075	1175	1250	1325	1425	1500		
	4.5	222	289	370	444	511	600	666	733	822	888	950	1044	1110	1178	1267	1332		
	5	200	260	340	400	460	540	600	660	740	800	860	940	1000	1060	1140	1200		
	5.5	182	236	309	362	418	491	543	600	673	724	782	855	905	964	1036	1036		
	6	167	217	283	334	383	450	500	550	617	668	717	783	835	883	950	1000		
	6.5	154	200	262	308	354	415	432	503	569	616	662	723	770	815	877	924		
MILS	7	143	186	243	286	329	386	429	471	529	572	614	671	715	757	814	858		
	7.5	133	173	227	266	307	360	399	440	493	532	573	627	665	707	760	795		
	8	125	163	213	250	288	338	375	413	463	500	538	588	625	663	713	750		
	8.5	118	153	200	234	271	318	351	388	435	468	506	553	585	624	671	702		
	9	111	144	189	222	256	300	333	367	411	444	478	522	555	589	633	646		
	9.5	105	137	178	210	242	284	315	347	389	420	453	495	525	559	600	630		
	10	100	130	170	200	230	270	300	330	370	400	430	470	500	530	570	600		
	10.5								314	352	381	410	448	476	505	543	511		
	11								300	336	367	390	427	455	482	518	545		
	11.5									322	348	374	409	435	461	496	522		
	12									308	333	353	392	417	442	475	500		
	12.5										320	344	376	400	424	456	480		
	13										308	331	362	385	408	438	462		
	13.5											319	348	370	393	422	444		
	14											307	336	357	379	407	429		
14.5	1)	ESTIMATE HEIGHT OF TARGET AND LOCATE ACROSS THE TOP											324	345	366	393	414		
15													313	333	353	380	400		
15.5	2)	MEASURE HEIGHT OF TARGET IN MILS AND LOCATE DOWN THE SIDE											303	323	342	368	387		
16														313	325	356	375		
16.5	3)	MOVE DOWN FROM THE TOP AND RIGHT FROM THE SIDE TO FIND THE RANGE IN YARDS											303	321	345	364			
17															312	335	353		
17.5															302	326	343		
18																317	333		
18.5													$\frac{\text{HEIGHT OF TARGET (YARDS)} \times 1,000}{\text{HEIGHT OF TARGET (MILS)}} = \text{RANGE (YARDS)}$					308	324
19																300	316		
19.5																	308		

APPENDIX B

BASIC SNIPER TRAINING SYLLABUS

1. HOURLY BREAKDOWN OF 8-WEEK PERIOD OF INSTRUCTION

HOURS	SUBJECT
4	Zeroing
20	Unknown Distance Firing
46	Stationary Target Firing
31	Moving Target Firing
8	Night Firing Under Artificial Illumination
15	Shooting Tests—Stationary/Moving Targets
30	Sniper/Marksmanship Related Classes
20½	Fire Support Planning/Control
50	Mission Planning
11½	Employment
16	Close Combat
42	Mapping/Aerial Photograph Instruction (6 Application Exercises)
1½	Written Test
44	Stalking Exercises (11 Exercises)
11	Range Estimation Exercises (11 Exercises)
11	Observation Exercises (11 Exercises)
6	Concealment Exercises (3 Exercises)
10	Hide Construction (1 Exercise)
48	Mission Exercises (2 Exercises, Each Covering a 24-Hour Period)
16	Tactical Exercise Without Troops (TEWT) (4 Exercises)
8½	Kim's Game
<hr/> 450	TOTAL HOURS

2. SNIPER PROFICIENCY TRAINING

The purpose of proficiency training is to enable the qualified sniper to maintain the degree of skill and proficiency to which he was trained. Proficiency training should be conducted quarterly in all sniper skills, although special emphasis should be made on marksmanship and stalking. These should be practiced as frequently as possible. Every effort should be made to maintain sniper proficiency.

Snipers should be requalified each year in all sniper skills. They should also be "quizzed" and/or tested every quarter.

Proficiency training should be conducted to the same degree of standards as it was originally taught so as not to lose any effectiveness in combat. If a sniper is not retrained quarterly, his quality of performance will decrease; therefore, he will not meet the standards of the Marine Corps scout sniper.

SNIPERS MUST BE INCLUDED, IN THE SNIPER ROLE, IN ALL NORMAL INFANTRY TACTICAL TRAINING AND IN TACTICAL EXERCISES.

APPENDIX C

MARKSMANSHIP EXERCISES

Marksmanship takes up a large portion of sniper training, both in schools and in proficiency training. The sniper may be proficient in all other areas of training, but without marksmanship, other areas are useless. There are five different marksmanship phases a sniper student must complete. They are:

- Stationary targets.
- Moving targets.
- Unknown distance firing.
- Firing under artificial illumination.
- Marksmanship test.

The following pages will consist of a lesson plan-type explanation of how to set up and conduct each of the firing exercises mentioned above.

1. STATIONARY TARGET FIRING

The purpose of stationary target firing is to make the sniper proficient in firing at stationary targets ranging from 300 to 1,000 yards.

The sniper student is given at least 10 rounds to fire at each yard line, starting from the 300-yard line and moving back to 1,000 yards.

DESCRIPTION

On a known distance range, it is necessary to ensure that:

- Communication equipment is available and functioning.
- Targets, carriages, extra uprights, pasters, and spotters are available.
- Ammunition is available.
- A range safety officer must be available, as well as a corpsman and an emergency vehicle.

RECONNAISSANCE BY THE CONDUCTING OFFICER/NCO

CONDUCT OF THE EXERCISE

The class must be split in half so that there is an even number of personnel in the pits and on the line.

On the line, the student will be issued his ammunition and briefed on the following:

- Aim of the exercise.
- Safety precautions on the line.
- What target to shoot at (per team).
- How many rounds per yard line.
- Time limit per shot.
- Standard to be achieved.

In the pits, the students will be briefed on the following:

- Procedures for pulling, marking, and spotting targets.
- Pit commands to be used.
- Safety precautions in the pits.

There should be two students per target on the line and in the pits.

The students will be positioned on each firing point so that one is firing, while the other is laying behind and to the right of the shooter observing wind conditions and plotting the shots (for a right handed shooter).

On the command, "LOAD AND BE READY," the student will chamber a round and place the weapon in his shoulder with the safety on.

On the command, "COMMENCE FIRING WHEN YOUR TARGET APPEARS," the students will fire all their allotted rounds for that yard line, one at a time, while the observer calls the wind and plots each shot.

At this point of the exercise, the line officer and/or instructors should be especially watchful for safety violations and weapon and ammo malfunctions.

Once the first student has fired all of his allotted rounds, the command, "CEASE FIRING ON THE LINE," will be given, followed by, "IS THE LINE CLEAR?" The weapons will be taken out of the shoulders and placed on "safe." The instructors will check the chambers.

The students on the line will then exchange positions on each firing point and wait for the commands.

The line officer will notify the pit officer when he will commence firing. The pit officer will, in turn, notify the target pullers with the command, "STAND BY TO RUN YOUR TARGETS IN THE AIR."

The pit officer will then say, "TARGETS, RUN THEM UP," upon which the students will raise the targets.

When a shot hole appears in the target, the puller will pull down the target, put a spotter in the shot hole and run the target back up, showing the shooter where he hit.

When the next shot hole appears, the puller will again pull down the target, move the spotter from the old shot hole to the new shot hole, paste the old shot hole and run the target back up. This procedure will be repeated until all rounds have been fired and the pit officer announces, "THE PITS ARE CLEAR. CHANGE OVER."

The personnel in the pits will replace the personnel on the line and vice versa.

The targets used for all stationary firing will be the Standard "B" Modified Requalification Target, or an FBI silhouette. *Student should fire from the supported prone position in most cases.*

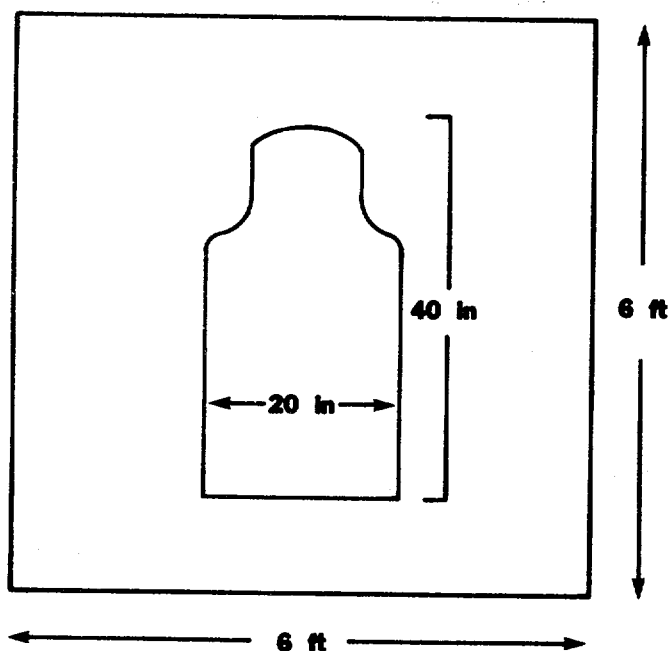

Figure C-1. Standard "B" Modified Requalification Target.

2. MOVING TARGET FIRING

The purpose of moving target firing is to make the sniper proficient in firing at moving targets ranging from 300 to 800 yards.

The students are given at least 10 rounds to fire at moving silhouettes at ranges from 300 to 800 yards. The targets move 8- to 10-target frames, perpendicular to the student on the firing line, and will then move back 8- to 10-target frames in the direction whence they came.

DESCRIPTION

RECONNAISSANCE BY THE CONDUCTING OFFICER/NCO

On the range to be utilized, the conducting officer or NCO must ensure that:

- Communication equipment is available and functioning.
- Targets, pasters, and spotters are available.
- Ammunition is available.
- A range safety officer must be available, as well as a corpsman, and an emergency vehicle.

CONDUCT OF THE EXERCISE

The class is split in half so that there is an even number of personnel on the line and in the pits.

On the line, the student will be issued ammunition and briefed on the following:

- Aim of the exercise.
- Safety precautions on the line.
- What target "sector" to shoot at.
- How many rounds per yard line.
- Time limit per shot.
- Standard to be achieved.

In the pits, the students will be given all the necessary equipment; i.e., targets, spotters, etc., and will be briefed on the following:

- Procedures for "walking the target."
- Procedures for pulling, marking, and spotting the target.
- Safety precautions in the pits.
- Pit commands to be used.

There should be two students for each target on the line and in the pits.

The target used for moving targets will be the "E" type pistol silhouette (cut to 12 inches wide) attached to a long stick or pole (usually 2 target frame sticks nailed together) and carried across the catwalk between 8 to 10 target frames, usually referred to as a "sector."

When the pit officer/NCO gives the command, "PUT YOUR TARGETS IN THE AIR," the students will raise the target approximately 2 to 3 feet above the butts.

The next command is "GO," where the students will walk at a normal pace (approximately 2 to 3 miles per hour) from their left limit to their right limit.

If the student gets a hit on the target while he is walking, he immediately pulls the target down and puts a spotter in the shot hole. He then runs the target back up while walking to his far limit, where he will quickly clear and paste the target, waiting for the commands to be repeated.

On the next shot, the pit puller walks back to his original point, at the same pace, with his target in the air to be shot at. He will repeat this back and forth procedure (by commands) until the shooter has completed firing. While one man is walking the target, the other is keeping score.

Scoring is a hit-or-miss system. If the shot hits the silhouette, it is scored as a hit. If it does not hit the silhouette, it is a zero.

On the line, the students will be positioned in teams on separate firing points, two men per point. One man shoots, while the other observes wind, adjusts the shooter's leads, and plots the shots in his partner's data book.

The line officer/NCO will give the command, "LOAD AND BE READY," and the student will assume a supported prone position, chamber a round, put the safety switch on safe, and wait for the next command.

The next command will be "COMMENCE FIRING WHEN YOUR TARGETS APPEAR."

The targets will come up and move to the right or left, and the sniper student must shoot the target before it reaches its sector limit. At this point, the line officer and/or instructors must be especially watchful for safety violations and weapon or ammunition malfunctions.

When the student is finished firing all his rounds, the "clearing" commands will be given and the student will change positions with his partner, and the above procedures will be repeated.

Once the two students on the line have finished firing all the yard lines, they will switch with the students in the pits.

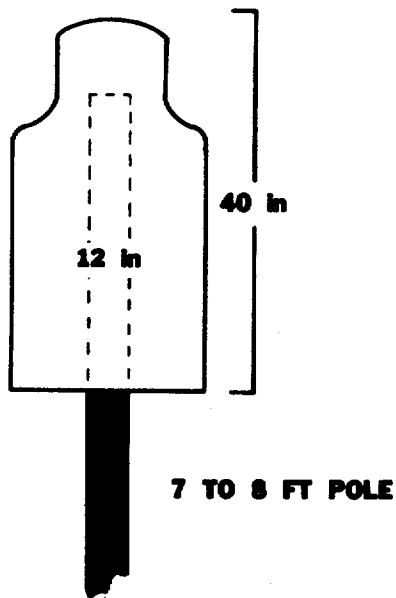

Figure C-2. The "E" Type Pistol Silhouette.

3. UNKNOWN DISTANCE FIRING

The purpose of this exercise is to make the sniper student knowledgeable in range estimation and proficient in engaging targets at unknown ranges.

DESCRIPTION

The sniper team must fill out a range card and field sketch prior to the firing exercise. They must then use their range estimations on the range card to engage their targets.

RECONNAISSANCE BY THE CONDUCTING OFFICER/NCO

There are certain requirements in unknown distance firing exercises unique to all other firing exercises. These requirements are:

- A large area, at least 1,000 yards long and 300 yards wide, with many types of terrain features.
- Five targets should be made for each team, with the team number on the target for easy identification by the team members.
- A range safety officer must be present during all firing, along with a corpsman and emergency vehicle.
- Ammunition must be available.

CONDUCT OF THE EXERCISE

The students will be brought out to the area, prior to firing, and told to fill out range cards and make field sketches (which will be graded as well as the firing scores).

Each team will be given five targets, set at ranges unknown to the students.

Each sniper student will fire two rounds per target at ranges up to 1,000 yards. Each target will have the team's assigned number painted on them and will be set at five different unknown ranges;

On command from the conducting officer/NCO, the students will engage their targets with a time limit of 20 minutes per team.

After each student has completed firing, the line will be cleared and the students allowed to go out to score and paste the targets.

Targets will be scored as 5 points per hit. Total team points is 100. Passing score for this firing exercise will be 80 percent of the total points available per man (40 points).

The targets used for unknown distance firing will be the full and partial "M" type standing silhouette.

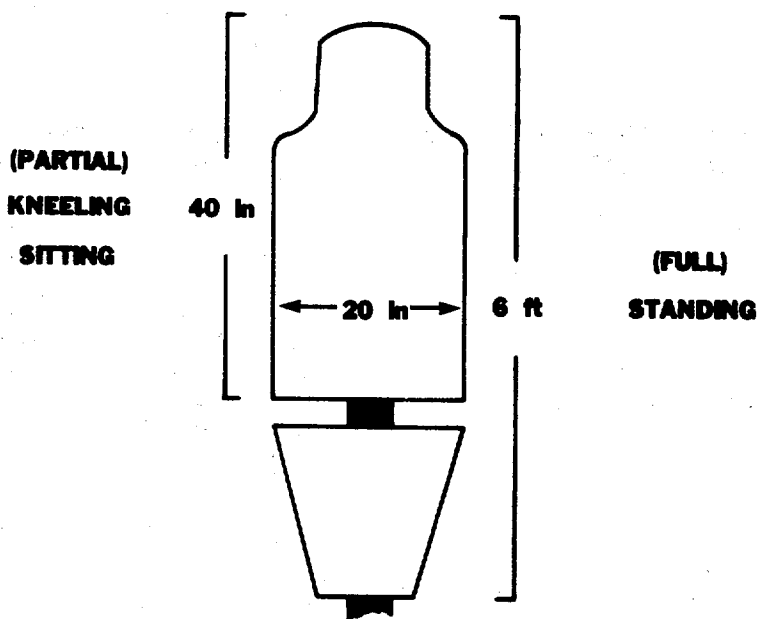

Figure C-3. Full and Partial "M" Type Standing Silhouette.

4. FIRING UNDER ARTIFICIAL ILLUMINATION

The purpose of this exercise is to make the sniper proficient in the proper holds for stationary targets and the proper leads for moving targets at distances ranging from 300 to 600 yards under artificial illumination.

The sniper students will fire at stationary targets and moving targets under artificial illumination at distances ranging from 300 to 600 yards. Both stationary and moving target firing should be conducted on separate nights due to the time involved to conduct one exercise.

DESCRIPTION

RECONNAISSANCE BY THE CONDUCTING OFFICER/NCO

Most of the requirements are the same as for other firing exercises, but there are some requirements unique to artificial illumination firing.

- "POP-UP" flares must be made available. They are White Star Illumination Flares with the DODIC number designation L312. To determine the amount needed, multiply the number of rounds per student by the amount of relays firing, then add 10 extra flares due to misfires and duds.
Example: 20 rounds per student x 4 relays = 80 + 10 extra = 90 flares. 100 flares would be a safe figure.
- Both stationary and moving targets must be made available, along with spotters and pasters.
- Flashlights for line and pit use must be available.
- Communication equipment must be available and functioning.
- A range safety officer must be present, as well as a corpsman and an emergency vehicle.
- Ammunition must be available.

CONDUCT OF THE EXERCISE

The conduct of the exercise will be explained in two sections (stationary targets and moving targets), since both exercises should not be fired on the same night.

STATIONARY TARGET FIRING UNDER ARTIFICIAL ILLUMINATION

Three to four hours should be set aside to fire this night exercise.

Set up the range and pits in the same manner as in the daytime stationary target firing exercises.

The time limit per round will be the time during which the flare is illuminating the range. When a flare goes up, firing commences. Firing ceases after each round when the flare goes out.

An instructor fires the flares one at a time, either from the line or pits, whichever is more convenient in adjusting the flare to the wind.

The instructor fires the flare according to the wind, so that the maximum amount of light will be on the targets for a maximum amount of time (duration of the flare).

When the instructor fires the flare, the student must fire one round while the flare is lit. The pit puller will pull and spot the target and run it back up before the flare goes out so the partner on the line can plot the shot in the data book.

If the student does not fire while the area is illuminated, he receives a miss. If he fires just before the flare goes out, the pit puller will spot the target on the next flare or with the flashlight.

The students must get 80 percent hits to pass the exercise.

The line procedures are the same as in the stationary target illumination firing.

The pit procedures are somewhat complicated and must be executed in a coordinated manner.

When the flare is launched, the sound of its launching can be heard in the pits. At this point, the targets are put in the air.

When the flare ignites, the pit puller starts walking the target across his assigned sector.

The student must fire during the illumination. If he does not fire, he receives a miss.

Due to the time involved in walking the target 8- to 10-target areas, the spotting of the targets will be done on the next flare so that the observer can adjust the shooter's lead.

When firing is finished, the range area should be checked for fires caused by drifting flares. If a fire is spotted, and is small enough, extinguish it; if it is becoming a large brush fire or looks like it might develop into a large fire, call the fire department immediately. Police up all flare debris.

The targets used for stationary target illumination firing will be the standard stationary target. The "B" modified standard requalification target or an FBI silhouette.

The targets used for moving target illumination firing will be the standard moving target. The "E" type pistol silhouette cut to 12-inches wide and mounted on a 7- to 8-foot stick or pole. (See par. 2)

5. MARKSMANSHIP TEST

The purpose of the marksmanship test is to evaluate the student in his ability to engage 35 designated targets at various ranges, scoring one point per hit with 80 percent accuracy.

MOVING TARGET FIRING UNDER ARTIFICIAL ILLUMINATION

DESCRIPTION

The student will be required to engage stationary targets at ranges from 300 to 1,000 yards and moving targets at ranges from 300 to 800 yards and must get at least 28 total hits (80 percent of 35 possible hits).

**RECONNAISSANCE BY THE
CONDUCTING OFFICER/NCO**

Communication equipment must be available and functioning.

Stationary and moving targets must be available, along with spotters, pasters, and extra target repair centers.

Scorecards for the pits and line must be available (only the pit score will be valid); verifiers should be present.

A range safety officer must be present, as well as a corpsman and emergency vehicle.

A 1,000-yard known distance range is needed.

**CONDUCT OF
ENGAGING STATIONARY TARGETS
FROM 300 TO 1,000 YARDS**

Each team will be assigned a block of eight targets, each block of which will be designated with the left and right limits marked with a 6-foot x 6-foot target mounted in two respective carriages. Thus, the right limit for one block will also serve as the left limit of the next block. The following targets will serve as left and right limits respectively: 1, 8, 15, 22, 29, 36, and 43. The stationary target will be mounted in the left limit target carriage of each block.

The first stage of fire at each yard line (300, 500, 600, 700, 800, 900, and 1,000) will be stationary targets from the supported prone position. Command will be given from the center of the line to load one round. The sniper and partner will have 3 minutes to judge wind, light condition, proper elevation hold, and fire three rounds with the target being pulled and marked after each shot. After the 3-minute time limit has expired, all stationary targets will be pulled down, cleared, and will remain in the pits. There will not be a changeover between sniper and observer until the sniper has engaged his moving targets, which should begin immediately after pulling the stationary targets in the pits.

**CONDUCT OF
ENGAGING MOVING TARGETS
FROM 300 TO 800 YARDS**

Each student will remain at their respective firing point after engaging stationary targets, so they can engage their moving targets within the assigned block of eight targets. One of the butt pullers will position himself at the left limit with the moving target, ready to move when the stationary stage is completed.

The second stage of fire at each yard line (300, 500, 600, 700, and 800) will be moving targets. The command will be given from the center of the line to load two rounds. Once the entire line is ready, a moving target will appear on the left limit of each block of targets, moving left to right. The sniper and partner will have approximately 15 to 20 seconds (the amount of time it takes the student to walk from the left limit to the right limit) in which to fire one round. The next target will move from the right limit to the left, and again, the sniper and his partner will have 15 to 20 seconds to fire one round. The target will be run up after each hit. It will also be up to the partner to advise the sniper on where his rounds are impacting (high, low, left, and right).

Moving targets will not be engaged past 800 yards. Therefore, five rounds will be fired and scored on stationary targets at 900 yards and 1,000 yards.

It will be the responsibility of the line officer/NCO to see that the entire test is run smoothly and safely. He will:

- Be the deciding factor should any complications or differences arise.
- Be responsible for briefing the pit officer/NCO on the conduct of the test and any other major items that he can foresee that will aid him in controlling the conduct of the test.
- Ensure that all commands are given clearly and precisely and that all students are allotted the same amount of time for firing.
- Ensure the required amount of ammunition is present and the appropriate range is signed out.
- Be responsible for the police of all firing lines.

It will be the responsibility of the pit officer/NCO to see that the test is run smoothly and safely for all personnel in the pits. He will:

- Contact the line officer/NCO should any complications or differences arise in the pits.
- Be responsible for briefing all students as to the conduct of fire and the pit procedures for that particular portion of the test.

CONDUCT OF THE LINE OFFICER/NCO

CONDUCT OF THE PIT OFFICER/NCO

- Ensure all commands are given clearly and precisely and the individuals on each block of targets record the number of hits received during both stages of fire.
- Ensure that the required amount of targets are readily available and that each block of targets is correctly implaced and properly manned.
- Be directly responsible for the police of the pit area.

TEST SCORING

Scoring will be conducted on the firing line as well as in the pits. Each student will fire 35 rounds at an assortment of stationary and moving targets from 300 to 1,000 yards. Each round will be valued at 1 point with a total value of 35 points. Passing score for the test is 80 percent of a "possible" score, which is 28 hits. A miss will be scored as zero. Final score will be determined by the pit score, and the verifiers.

Snipers will be given several rounds at 300 yards to check their "zero" prior to starting the test.

SNIPER QUALIFICATION COURSE

STAGE	YARD LINE	* TARGET TYPE	TARGETS FIRED	NO. ROUNDS RECEIVED ON TARGET	SCORE
1	300	S	3	3	3
2	300	M	2	2	2
3	500	S	3	3	3
4	500	M	2	2	2
5	600	S	3	3	3
6	600	M	2	2	2
7	700	S	3	3	3
8	700	M	2	2	2
9	800	S	3	3	3
10	800	M	2	2	2
11	900	S	5	5	5
12	1,000	S	5	5	5

35 Points

*S = STATIONARY
M = MOVING

APPENDIX D

SNIPER TRAINING EXERCISES

1. STALKING EXERCISES

The purpose of stalking exercises is to give the sniper confidence in his ability to approach and occupy a firing position without being observed.

Having studied a map (and aerial photograph, if available), individual students must stalk for a predesignated distance, which could be 1,000 yards or more, depending on the area selected. All stalking exercises and tests should be approximately 1,000 yards with a 4-hour time limit. The student must stalk to within 150 to 200 yards of two trained observers, who are scanning the area with binoculars, and fire two blanks without being detected.

DESCRIPTION

The area used for a stalking exercise must be chosen with great care. An area in which a student must do the low crawl for the complete distance would be unsuitable. The following items should be considered:

RECONNAISSANCE BY THE CONDUCTING OFFICER/NCO

- As much of the area as possible should be visible to the observer. This forces the student to use the ground properly, even when far from the observer's location.
- Where possible, available cover should decrease as the student nears the observer's position. This will enable him to take chances early in the stalk and force him to move more carefully as he closes in on his firing position.
- The students must start the stalk in an area out of sight of the observer.
- Boundaries must be established by means of natural features or the use of markers.

CONDUCT OF THE EXERCISE

In a location near the jumpoff point for the stalk, the student is briefed on the following:

- Aim of the exercise.
- Boundaries.
- Time limit (usually 4 hours).
- Standards to be achieved.

After the briefing, the students are dispatched at intervals to avoid congestion.

In addition to the two observers, there are two "walkers," equipped with radios, who will position themselves within the stalk area. If an observer sees a student, he will contact a walker by radio and direct him to within 5 feet of the student's location. Therefore, when a student is detected, the observer can immediately tell the student what gave him away.

When the student reaches his firing position, which is within 150 to 200 yards of the observer, he will fire a blank at an observer. This will tell the walker he is ready to continue the rest of the exercise. The walker will then move to within 10 yards of the student. The observer will search a 10-yard radius around the walker for the sniper student. If the student is undetected, the walker will tell him to chamber and fire his second blank. If the sniper is still unseen, the walker will then point in the student's direction, and the observer will search in detail for anything that indicates a human form, rifle, or equipment. If the sniper remains undetected, the walker will then move in and put his hand on the student's head. The observer will again search in detail. If the sniper student is not seen at this point, he must tell the walker which observer he fired at and what the observer is doing. The observer waves his hat, scratches his face, or makes some gesture that the student can identify when using his telescope. The sniper student must then tell the walker his exact range, wind velocity, and windage applied to the scope. If the sniper completes all of these steps correctly, he has passed the stalk exercise.

A critique is conducted at the conclusion of the exercise, touching on main problem areas.

To create interest and to give the students practice in observation and stalking skills, one-half of the class could be positioned to observe the conduct of the stalk. Seeing an error made is an effective way of teaching better stalking skills. When a student is caught, he should be sent to the observation post (OP) to observe the exercise.

CREATING INTEREST

2. RANGE ESTIMATION EXERCISES

Range estimation exercises are to make the sniper proficient in accurately judging distance.

The student is taken to an observation post, and different objects over distances of up to 1,000 meters are indicated to him. After time for consideration, he writes down the estimated distance to each object. He may use only his binoculars and rifle telescope as aids, and he must estimate to within 10 percent of the correct range (a 6-foot man-sized target should be utilized).

Each exercise must take place in a different area, offering a variety of terrain. The exercise areas should include dead space as well as places where the student will be observing uphill or downhill. Extra objects should be selected in case those originally chosen cannot be seen due to weather, or for other reasons.

CONDUCT OF THE EXERCISE

The students are brought to the observation post, issued a record card, and given a review on methods of judging distances and causes of miscalculation. They are then briefed on the following:

- Aim of the exercise.
- Reference points.
- Time limit per object.
- Standard to be achieved.

Students are spread out and the first object is indicated. The student is allowed 3 minutes to estimate the distance and write it down. The sequence is repeated for a total of eight objects. The cards are collected, and the correct range to each object is given. The instructor points out in each case why the distance might be underestimated or overestimated. After correction, the cards are given back to the students. In this way, the student retains a record of his performance.

STANDARDS

The student is deemed to have failed if he estimates three or more distances incorrectly.

DESCRIPTION

RECONNAISSANCE BY THE CONDUCTING OFFICER/NCO

3. OBSERVATION EXERCISES

The purpose of observation exercises is to practice the sniper's ability to observe an enemy and accurately record the results of his observations.

DESCRIPTION

The student is given an arc of about 1,800 miles to observe for a period of not more than 40 minutes. He is issued a panoramic sketch of his arc and is expected to plot on the sketch any objects he sees in his area. Objects are so positioned as to be invisible to the naked eye, indistinguishable when using binoculars, but recognizable when using the spotting telescope.

RECONNAISSANCE BY THE CONDUCTING OFFICER/NCO

In choosing the location for the exercise, the following points should be considered:

- Number of objects in the arc.
- Time limits.
- Equipment which they are allowed to use (binoculars and spotting telescopes).
- Standard to be attained.

Each student takes up the prone position on the observation line and is issued a panoramic sketch of the area. The staff is available to answer questions about the sketch if a student is confused. (If the class is large, the observation line could be broken into a right and left half. A student could spend the first 20 minutes in one half and then move to the other. This ensures that he sees all the ground in the arc.) At the end of 40 minutes, all sheets are collected and the students are shown the location of each object. This is best done by the students staying in their positions and watching while a member of the staff points out each object. In this way, the students will see why they failed to find an object, even though it was visible. (Students should view first with binoculars and then with spotting telescopes before the instructor picks the item up.)

A critique is then held, bringing out the main points.

Students are given half a point for each object correctly plotted and another half point for naming the object correctly.

SCORING

The student is deemed to have failed if he scores less than 8 points out of a total of 12 points (12 disguised military objects).

STANDARDS

4. MEMORY EXERCISE (KIM'S GAME)

The purpose of the memory exercise is to teach the sniper student to observe and remember a number of unrelated objects. In combat, the sniper requires a good memory in order to report facts accurately, because he may not be in a position to write them down. The Kim's game is to help the student in observation techniques. The better he does on the Kim's games, the more confident he will be during the observation exercises.

The instructor places 12 small objects on a table. They could be anything from a paper clip to a 40mm round. He notes the name of each object and its most distinguishable features (color, shape, size, lettering, etc.).

The students are placed in a circle around a covered table and told the purpose of the exercise. The instructor tells the students there are 12 objects on the table. He explains that they have a small amount of time to look and a slightly longer amount of time to write. This could range from 2 minutes to look and 2½ minutes to write on the first exercise to 20 seconds to look and 30 seconds to write on the last exercise. After the "looking" time limit is up, the students are given a time limit to write down what they saw. Papers are collected, and the objects are again displayed to show the students what they missed.

DEGREE OF DIFFICULTY

Successive games can be increased in difficulty by:

- Shortening the time limits to look and write.
- Creating distractions, such as music, noise, etc.
- Sending the students on a short run after they view the objects, then giving them a shorter amount of time to write.
- Having the students go on a scheduled field craft exercise after viewing the objects, then after returning (1 or 2 hours later), having them write down what they saw in the Kim's game.

5. HIDE CONSTRUCTION EXERCISE

The purpose of the hide construction exercise is to show the sniper how to build a hide and remain undetected while being observed. The purpose of a hide is to camouflage a sniper or sniper team which is not in movement.

The sniper students are given 8 hours to build a temporary hide large enough to hold a sniper team with all their necessary equipment.

The hide exercise area should be selected with great care. It can be in any type of terrain, but there should be more than enough prospective spots in which to build a hide. The area should be easily bounded by left and right, far and near limits so that when the instructor points out the limits to the students, they can be easily and quickly identified. There should be enough tools (i.e., axes, picks, shovels, and sandbags) available to accommodate the entire class. There must be sufficient rations and water available to the students to last the entire exercise, which is about 9½ hours total—8 hours construction, 1½ hours testing.

CONDUCT OF THE EXERCISE

The students are issued a shovel, ax, pickax, and approximately 20 sandbags per team. The students are brought to the area and briefed on the purpose of the exercise, their time limit for construction, and their area limits. The students are then allowed to begin construction of their hides.

Note: During the construction, an instructor should be present at all times to act as an advisor.

At the end of 8 hours, the students' hides are all checked to ensure that they are complete. An infantry officer is brought out to act as an observer. He is placed in an area 300 yards from the hide area, where he starts his observation with binoculars and a 20X, M49 spotting scope. The observer, after failing to find a hide, is brought forward 150 yards and again commences observation.

An instructor in the field (walker with radio) then moves to within 10 yards of a hide and informs the observer. The observer then tells the walker to have the sniper in the hide to load and fire his only round (blank). If the sniper's muzzle blast is seen, or if the hide is seen due to improper construction, the team fails, but they remain in the hide. These procedures are repeated for all the sniper teams. The observer is then brought down to within 25 yards of each hide to determine whether they can be seen with the naked eye at that distance. The observer is not shown the hide. He must find it. If the sniper team is located at 25 yards, it fails and is allowed to come out and see its discrepancies. If the team is not seen, it passes.

DESCRIPTION

RECONNAISSANCE BY THE CONDUCTING OFFICER/NCO

OTHER REQUIREMENTS

The sniper teams should also be required to fill out a range card and a sniper's log book and make a field sketch. One way of helping them achieve this is to have an instructor showing "flash cards" from 150 yards away, beginning when the observer arrives and ending when the observer moves to within 25 yards. The sniper teams should record everything they see on the flash cards and anything going on at the observation post during the exercise.

STANDARDS

The sniper teams are required to pass all phases in order to pass the exercise. All range cards, log books, and field sketches must be turned in for grading and a final determination of pass or fail.

6. CAMOUFLAGE AND CONCEALMENT EXERCISES

Camouflage and concealment exercises are held to help the sniper student to select final firing positions.

The student conceals himself within 200 yards of an observer, who, using binoculars, tries to find the student. The student must be able to fire blank ammunition at the observer without being seen, and have the correct elevation and windage on his sight. The student must remain unseen throughout the conduct of the exercise.

DESCRIPTION

In choosing the location for the exercise, the instructor ensures that certain conditions are met. These are:

- There must be adequate space to ensure students are not crowded together in the area. There should be at least twice the number of potential positions as there are students. Once the area has been established, the limits should be marked in some manner (e.g., flags, trees, prominent features, etc.). Students should then be allowed to choose any position within the limits for their final firing position.
- The observer must be located where he can see the entire problem area.

RECONNAISSANCE BY THE CONDUCTING OFFICER/NCO

As there will be several concealment exercises throughout the sniper course, different types of terrain should be chosen in order that the students may practice concealment in varied conditions. For instance, one exercise could take place in a fairly open area, one along a wood line, one in shrubs, and another in hilly or rough terrain.

CONDUCT OF THE EXERCISE

The sniper is given a specified area with boundaries in which to conceal himself properly. The observers turn their backs to the area and allow the students 5 minutes to conceal themselves. At the end of 5 minutes, the observers turn and commence observation in their search for concealed snipers. This observation should last approximately one-half hour (more time is allotted, if desired). At the conclusion of observation, the observer will instruct, by radio, one of the two observers (walkers) in the field to move to within 10 meters of one of the snipers. The sniper is given one blank. If he cannot be seen after the walker moves within the 10 meters, the walker will tell him to load and fire his blank. The observer is looking for muzzle blast, vegetation flying after the shot, and movement by the sniper before and after he fires. If the student cannot be seen, the walker then extends his arm in the direction of the sniper, indicating his position. If the sniper remains unseen after indication, the walker goes to the sniper's position and places his hand, palm facing the observer, directly on top of the sniper's head. If the sniper passes all of the above, he must then state his elevation, windage, and what type of movement the observer is making.

To create interest and to give students practice in observation, one-half of the class may be positioned with the observer in order that they can profit from the mistakes of the other half of the class. When a student fails the exercise, he should go to the observation post to observe.

CREATING INTEREST

APPENDIX E

WINDAGE CONVERSION TABLE

RANGE IN YARDS	2 MPH		4 MPH		6 MPH		8 MPH		10 MPH		12 MPH		14 MPH		16 MPH		18 MPH		20 MPH		
	WIND VALUE	MIN. IN.	MIN. IN.	MIN. IN.	MIN. IN.	MIN. IN.	MIN. IN.	MIN. IN.	MIN. IN.	MIN. IN.	MIN. IN.	MIN. IN.	MIN. IN.	MIN. IN.	MIN. IN.	MIN. IN.	MIN. IN.	MIN. IN.	MIN. IN.	MIN. IN.	
100	1/2	0	.073	1/8	.146	1/4	.219	1/4	.292	1/4	.365	1/2	.438	1/2	.511	1/2	.584	3/4	.657	3/4	.73
	FULL	1/8	.146	1/4	.292	1/2	.584	1/2	.584	3/4	.73	3/4	.876	1	1.022	1 1/4	1.168	1 1/4	1.314	1 1/2	1.460
200	1/2	0	.3	0	.6	1/2	.9	1/2	1.2	1	1.5	1	1.8	1	2.1	1	2.4	1	2.7	1 1/2	3.
	FULL	0	.6	1/2	1.2	1	1.8	1	2.4	1 1/2	3	2	3.6	2	4.2	2 1/2	4.8	2 1/2	5.4	3	6.
300	1/2	0	.7	1/2	1.4	1/2	2.1	1	2.8	1	3.5	1 1/2	4.2	1 1/2	4.9	2	5.6	2	6.3	2 1/2	7.
	FULL	1/2	1.4	1	2.8	1 1/2	4.2	2	5.6	2	7	2 1/2	8.4	3	9.8	4	11.2	4	12.6	4.5	14.
400	1/2	1/2	1.25	1/2	2.5	1	4.	1	5.25	1 1/2	6.5	2	7.75	2	9.	2 1/2	10.5	3	11.75	3	13.
	FULL	1/2	2.5	1	5.0	2	8.	2 1/2	10.5	3	13	4	15.5	4 1/2	18.	5	21	6	23.5	6 1/2	26.
500	1/2	1/2	2.0	1	4.0	1	6.5	1 1/2	8.5	2	11.	2 1/2	13.	3	15	3 1/2	17	4	19	4 1/2	21.5
	FULL	1	4.5	1 1/2	8.5	2 1/2	13.	3 1/2	17.	4	21.5	5	26.	6	30	7	34.5	8	38.5	8 1/2	43.
600	1/2	1/2	3.0	1	6.5	1 1/2	10.	2	13.	2 1/2	16	3	19.5	3 1/2	23	4 1/2	26	5	29	5 1/2	32.5
	FULL	1	6.5	2	13.	3	19.5	4 1/2	26.	5 1/2	32.5	6 1/2	39.	7 1/2	45.5	8 1/2	52	9 1/2	58.5	11	65.
700	1/2	1	5.	1	9.	2	14.	2 1/2	18.5	3	23	4	28	4 1/2	32.5	5	37	6	42	6 1/2	46.5
	FULL	1	9.5	2 1/2	18.5	4	28.	5	37	6 1/2	46.5	8	56	9 1/2	65	10 1/2	74.5	12	83.5	13	93.0
800	1/2	1	6.	1 1/2	13.	2	19.	3	25.5	4	32	5	38	5 1/2	44.5	6 1/2	51	7	57	8	63.5
	FULL	1 1/2	12.5	3	25.5	4 1/2	38	6 1/2	51	8	63.5	9 1/2	76	11	89	12 1/2	101.5	14	114.5	16	127
900	1/2	1	8.5	2	17	3	25	4	34	4 1/2	42	5 1/2	51	6 1/2	59	7 1/2	67	8 1/2	76	9 1/2	84.5
	FULL	2	17.	4	34	5 1/2	50.5	7 1/2	67.5	9 1/2	84.5	11	101.5	13	118.5	15	135	17	152	19	169
1000	1/2	1	11.	2	22	3	32.5	4.	43.5	5 1/2	54	6 1/2	65	7 1/2	76	8 1/2	87	10	98	11	108.5
	FULL	2	21.5	4	43.5	6 1/2	65.	8 1/2	87	10 1/2	108.5	13	130	15	152	17 1/2	173.5	19 1/2	195.5	21 1/2	217
1100	1/2	1	13.5	2 1/2	27	4	41	5	54.5	6	68	7 1/2	81.5	9	95	10	109	11	122.5	12	136
	FULL	2 1/2	27.	5	54.5	7 1/2	81.5	10	109	12	136	15	163	17	190.5	19 1/2	217.5	22	245	24 1/2	272

NOTE: All measurements of inches beyond 400 yards rounded off to nearest 1/2 inch. All computations from the Small Arms Ammunition Manufacturing Institute are for 173-grains boattail, at 2,600 feet per second; the difference between this and the 2,580 feet per second of the sniper rifle is negligible.

APPENDIX F**BUILDING TERRAIN MODELS**

A terrain model is a scale model showing land forms, natural and man-made features, etc. Its main purpose is to provide a means for visualizing the terrain for planning and briefing of sniper missions, route selection, position selection, etc.

PURPOSE

The materials used in making terrain models consist of maps, aerial photographs, and current intelligence of the area involved. Maps provide the topographic information, aerial photos provide up-to-date changes of terrain and man-made features, while intelligence provides the situation information regarding both friendly and enemy forces.

MATERIALS

There are infinite amounts of materials that can be used in making terrain models. They can be made anywhere out of almost any material available. Some of the items are: paint, plywood, cardboard, plaster, paper mache, cheese cloth, burlap, sawdust, cotton, wire, wood pegs, nails, sections of moss, sod, sand, etc. There are also different places to build them; in a wood box, a wash bucket, a hole in the ground, etc. Field expedients are never-ending.

CONSTRUCTION

One of the first factors to be considered in making a terrain model is the scale. Different type scales may be used depending on how large the model is to be. A simple scale of 1:2,000 taken from a 1:50,000 map would be:

50 centimeters	=	1,000 meters
5 centimeters	=	100 meters
1 centimeter	=	20 meters
1 millimeter	=	2 meters

**For additional information on how to build a terrain model,
see TM 5-249, *Terrain Models and Relief Map Making*,
Department of the Army, April 1956.**

APPENDIX G

LIST OF REFERENCES

1. FLEET MARINE FORCE MANUALS

FMFM 1-3, Basic Rifle Marksmanship
FMFM 1-3A, Field Firing Techniques
FMFM 6-4, Marine Rifle Company/Platoon
FMFM 6-5, Marine Rifle Squad
FMFM 7-1, Fire Support Coordination
FMFM 7-4, Field Artillery Support

2. U.S. ARMY MANUALS

FM 6-20, Fire Support in Combined Arms Operations
FM 6-40, Field Artillery Cannon Gunnery
FM 6-40-5, Modern Battlefield Cannon Gunnery
FM 21-26, Map Reading
FM 21-75, Combat Training of the Individual Soldier and Patrolling
FM 23-85, 60MM Mortar, M19
FM 23-91, Mortar Gunnery
FM 30-5, Combat Intelligence
TM 5-249, Terrain Models and Relief Map Making

INDEX

	Paragraph	Page
A		
Adjustments		
Focus adjustment204	2-13
Interpupillary adjustments204	2-13
Ammunition203	2-9
B		
Basic sniper training syllabusApp B	B-1
Building terrain modelsApp F	F-1
C		
Camouflage403	4-9
Blending/deceiving403	4-15
Camouflaging equipment403	4-12
Field expedients403	4-11
Geographic areas403	4-13
Patterns403	4-10
Stick camouflage403	4-10
Care and cleaning of rifle and equipment206	2-22
Collection and reporting of information502	5-12
Conventional representation of features501	5-10,5-11
D		
Dual mission102	1-1
Defensive employment		
Ambush patrol603	6-19
Combat outpost603	6-20
Deep insertions603	6-20
Linear defense603	6-16
Patrol bases603	6-20
Perimeter defense603	6-16
Raids603	6-20
Reverse slope defense603	6-16
Riverline defense603	6-17
Duties106	1-5
E		
Effect of weather310	3-17
Elevation and windage202	2-7
F		
Factors affecting range estimation402	408
Fire support control705	7-15

	Paragraph	Page
Focus204	2-11
Adjustment204	2-13
Field sketching, panoramic sketch501	5-5
Conventional representation of features501	5-10
Delineation501	5-9
Other methods of field sketching501	5-11
G		
Geographical areas of intelligence operations502	5-13
Intelligence cycle502	5-14
Intelligence requirements502	5-16
Specific requirements for planning the attack502	5-16
H		
Hasty position405	4-31
Holds and leads		
Angle of target movement311	3-20
Holdoff311	3-20,3-21
Holds311	3-20
Leads311	3-20
I		
Individual movement404	4-16
Stalking404	4-22
Interpupillary adjustments204	2-13
L		
Lens coating202	2-3
List of references	App G	G-1
M		
M16 quick kill method307	3-12
M401A1 rifle		
Care and cleaning206	2-22
Tabulated data201	2-2
Marksmanship exercises	App C	C-1
Marksmanship training301	3-1
Factors common in all positions301	3-7,3-8
Fundamentals302	3-1
Progressive training303	3-1
Shooting positions306	3-6
Sighting and aiming304	3-2
Trigger control305	3-5
Mounting the telescope202	2-8

	Paragraph	Page
O		
Observation aids204	2-10
Observation log501	5-4
Observer, shooter positioning308	3-13
Occupation and selection of positions405	4-28
Concealment in hasty position405	4-32
Following routes405	4-30
Hasty position405	4-31
Selecting routes405	4-29
Offensive combat602	6-5
Employment of the sniper602	6-5
Operational concept103	1-2
Optical equipment maintenance206	2-24
Organization, scout sniper105	1-4
P		
Parallax202	2-4
Patrol order705	7-12
Administrative and logistics705	7-13
Command and signal705	7-13
Patrol steps703	7-6
Estimate of the situation703	7-6
Tentative plan of action703	7-8
R		
Range card501	5-1
Field expedient range card501	5-2
Use501	5-3
Range estimation402	4-5
Estimating by eye402	4-5
Appearance of objects method402	4-6
Bracketing method402	4-6
Combination method402	4-6
Range card method402	4-6
Range estimation formula method402	4-6
100-yard increment method402	4-6
Limitations402	4-8
Range estimation tables		
ObjectsApp A	A-2
PersonnelApp A	A-1
Requirements for possible sniper candidates107	1-7
Reticle202	2-6
S		
SALUTE report502	5-21
Scout-sniper, definition101	1-1

	Paragraph	Page
Selection of personnel107	1-6
Skills additionally trained in.103	1-3
Sniper employment officer702	7-1
Debriefing702	7-5
Sniper equipment201	2-1
Sniper tactical employment601	6-1
Concept of employment601	6-1
Sniper team103	1-2
Sniper training exercisesApp D	D-1
Sniper positions, selecting405	4-28
General rules and considerations405	4-46
Stalking404	4-22
Starlight scope.205	2-15
Employment.205	2-18
Installation.205	2-16
Maintenance.205	2-21
Mounting.205	2-16
Zeroing during daylight205	2-17
Zeroing during dawn or dusk205	2-17

T

Tabulated data, M401A1 rifle201	2-2
Target detection.401	4-1
Indicators401	4-3,4-4
Target selection401	4-4,4-5
Considerations.401	4-4
Techniques in constructing and concealing (hides).405	4-34
Positions in a built-up area.405	4-40
Telescopic sight202	2-2
Terrain models, buildingApp F	F-1
Training syllabusApp B	B-1

U

UNERTL USMC sniper scope, tabulated data.202	2-3
---	------	-----

W

Warning order704	7-11
Discussion704	7-11
Weather, effect310	3-17
Wind310	3-17
Classification310	3-17
Determine windage adjustment310	3-19
Flag method310	3-18
Observation method310	3-18
Velocity310	3-17
Windage conversion tableApp E	E-1

	Z	Paragraph	Page
Zeroing309	3-14
Zone briefs708	7-18